

BZH02/A0330/03 Datasheet

**Product Name // Horizontal Power Entry Module 62.7mm
C14 Cold Condition Inlet Integral Single Fused (PF0011)
2.8mm Tab Termination A0330 Filter (3A PS21/A L/C v3) Red
Indicator**

 [View Product Page](#)

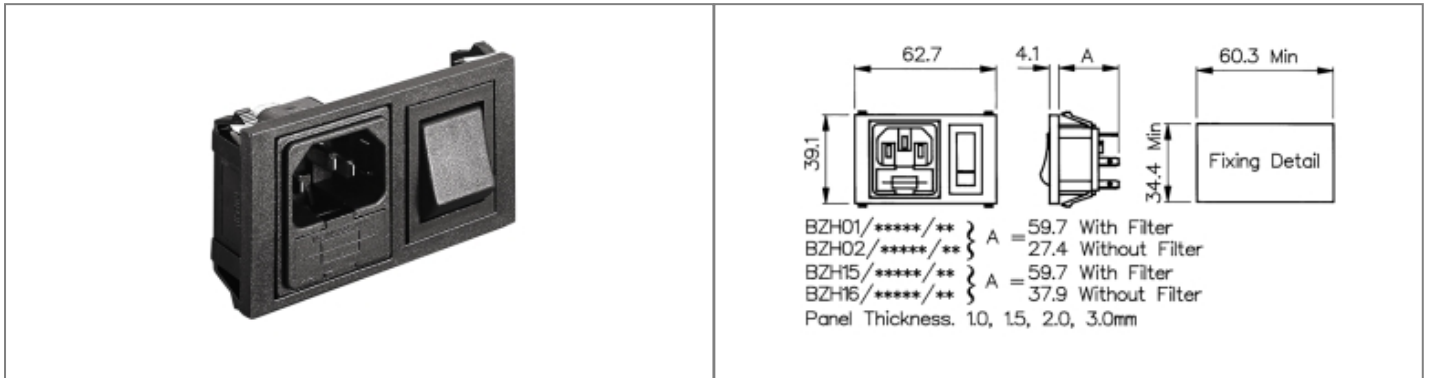

// Product Description:

- ⊕ Horizontal Power Entry Module 62.7mm/74.5mm
- ⊕ C14 Cold Condition Inlet with integral fuseholder(s) depending on part code:
- ⊕ Part codes prefixed BZH01, BZH02: PF0011 Single Fused Inlet
- ⊕ Part codes prefixed BZH15, BZH16: PF0033 Twin Fused Inlet
- ⊕ Choice of Termination depending on part code:
- ⊕ Part codes prefixed BZH01, BZH15: 6.3mm Tab
- ⊕ Part codes prefixed BZH02, BZH16: 2.8mm Tab
- ⊕ Choice of mains filter depending on part code:
- ⊕ Part codes containing /Z0000 are unfiltered
- ⊕ Choice of mains filter options (part codes containing codes starting /A)
- ⊕ Choice of many other options as specified by individual part code, including indicators, illuminated switches, switch markings, etc

// General Information:

Product Display Title:	Horizontal Power Entry Module 62.7mm/74.5mm
Product Family:	IEC Connectors
Product Series:	Power Entry Modules
Current Max:	3A
Filter Type:	3A PS21/A L/C v3
Function:	C14 Inlets
Fuseholder Inlet Type:	Integral Single Fused
iec Connector Components:	None
iec Connector Mates With:	PF0011
iec Filter Options:	A0330
iec Horizontal Module Width:	62.7mm
iec Neon Colour:	Red
Inlet Type:	C14 Cold Condition Inlet
Voltage Max:	250V

// Product PDF Links

 [Power Entry Modules product data](#)

// Product 3D CAD Model Links

 [BZH02/A0330/033D CAD Model](#)