

BZV45/Z0000/71 Datasheet

Product Name // Vertical Power Entry Module 58.4mm
Sheet F Non-Shuttered Outlet (PX0695) 6.3mm Tab
Termination Unfiltered Single Contact Illuminated Switch
Marked I/O Red

 [View Product Page](#)

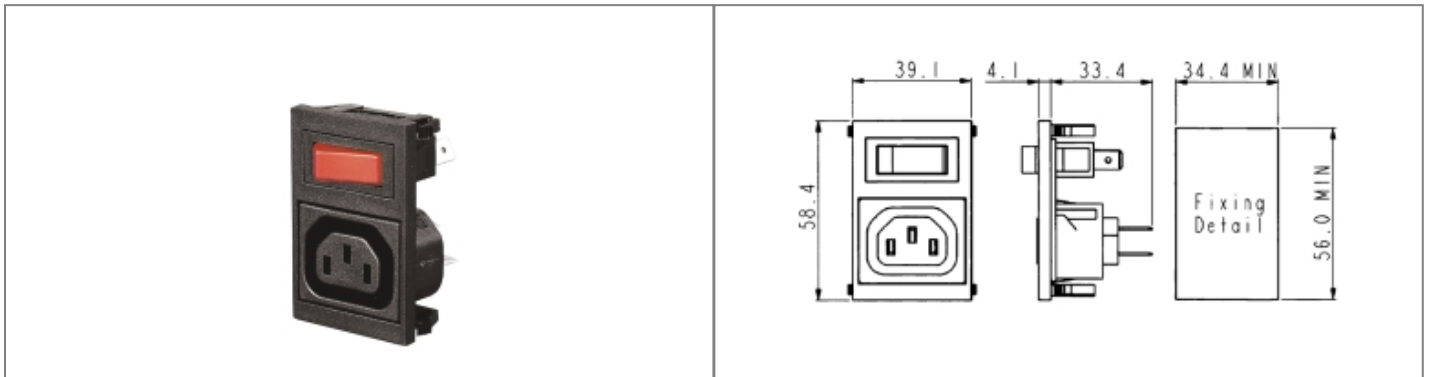

// Product Description:

- ⊕ Vertical Power Entry Module 58.4mm
- ⊕ Sheet F Shuttered (PX0783) or Non-Shuttered (PX0695) Outlet:
- ⊕ Part codes prefixed BZV47, BZV48: Shuttered Outlet
- ⊕ Part codes prefixed BZV45, BZV46: Non-Shuttered Outlet
- ⊕ Choice of Termination depending on part code:
- ⊕ Part codes prefixed BZV45, BZV47: 6.3mm Tab
- ⊕ Part codes prefixed BZV46, BZV48: 2.8mm Tab
- ⊕ Choice of switch and illumination options as specified by individual part code

// General Information:

Product Display Title:	Vertical Power Entry Module 58.4mm
Product Family:	IEC Connectors
Product Series:	Power Entry Modules
Current Max:	10A
Filter Type:	Unfiltered
Function:	Power Entry Module Sheet F Outlet
IEC Connector Components:	None
IEC Connector Mates With:	PX0695
IEC Filter Options:	Unfiltered
IEC Neon Colour:	Red
IEC Vertical Module Height:	58.4mm
Inlet Type:	Sheet F Non-Shuttered Outlet
Switch Type:	Single Contact Marked I/O Illuminated
Voltage Max:	250V

// Product PDF Links

 [Power Entry Modules product data](#)

// Product 3D CAD Model Links

 [BZV45/Z0000/713D CAD Model](#)