

# BZV46/Z0000/69 Datasheet

**Product Name // Vertical Power Entry Module 58.4mm**







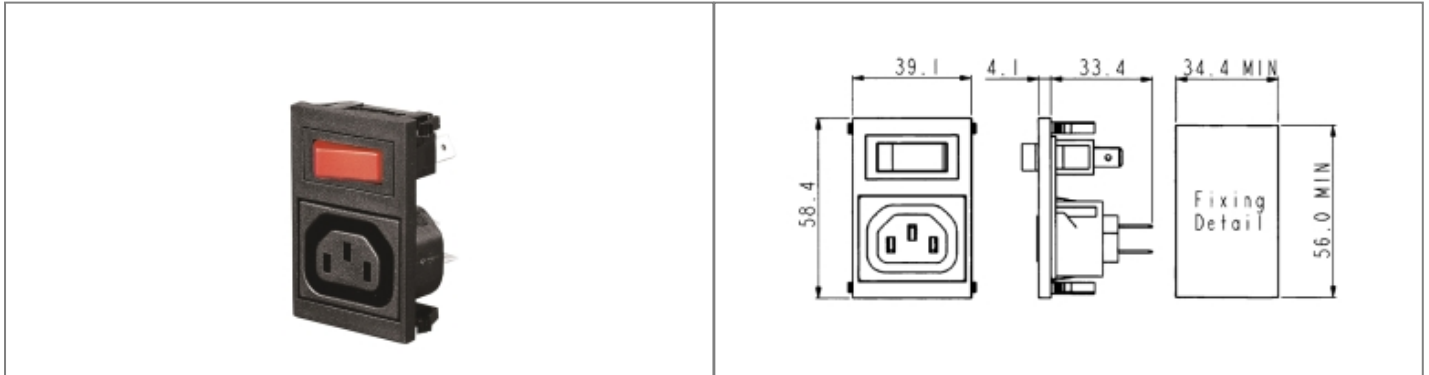

**Sheet F Non-Shuttered Outlet (PX0695) 2.8mm Tab**

**Termination Unfiltered Single Contact Switch Marked I/O**

 [View Product Page](#)



## // Product Description:

-  Vertical Power Entry Module 58.4mm
-  Sheet F Shuttered (PX0783) or Non-Shuttered (PX0695) Outlet:
-  Part codes prefixed BZV47, BZV48: Shuttered Outlet
-  Part codes prefixed BZV45, BZV46: Non-Shuttered Outlet
-  Choice of Termination depending on part code:
-  Part codes prefixed BZV45, BZV47: 6.3mm Tab
-  Part codes prefixed BZV46, BZV48: 2.8mm Tab
-  Choice of switch and illumination options as specified by individual part code

## // General Information:

Product Display Title:	Vertical Power Entry Module 58.4mm
Product Family:	IEC Connectors
Product Series:	Power Entry Modules
Current Max:	10A
Filter Type:	Unfiltered
Function:	Power Entry Module Sheet F Outlet
iec Connector Components:	None
iec Connector Mates With:	PX0695
iec Filter Options:	Unfiltered
iec Vertical Module Height:	58.4mm
Inlet Type:	Sheet F Non-Shuttered Outlet
Switch Type:	Single Contact Marked I/O
Voltage Max:	250V

### // Product PDF Links

 [Power Entry Modules product data](#)

### // Product 3D CAD Model Links

 [BZV46/Z0000/693D CAD Model](#)