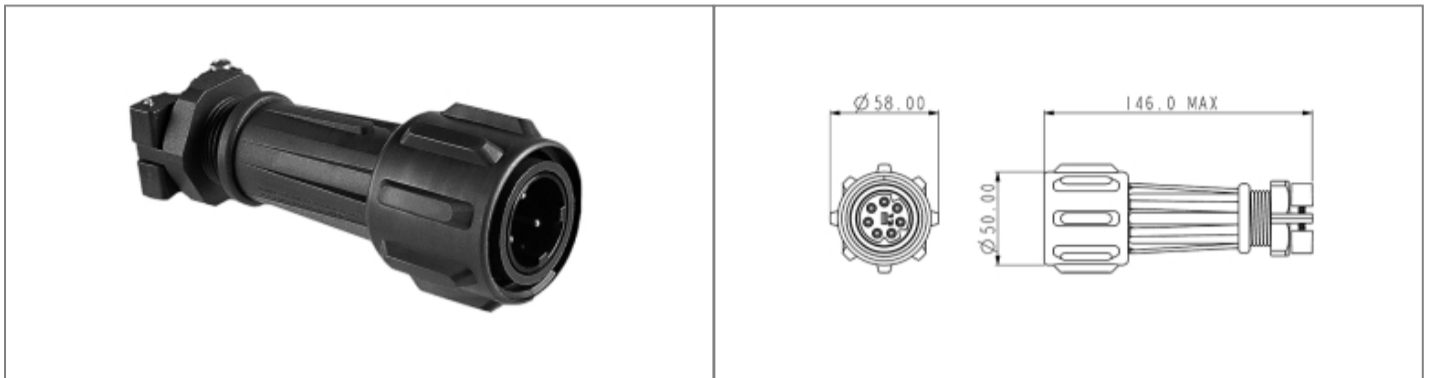

# EXP-A911/05/P Datasheet

## Product Name // Flex Cable Connector Large Cable EXP-A911 Series 5 Contact Plug 20mm-22mm Cable (Yellow Gland)

[View Product Page](#)

### // Product Description:

- Flex Cable Connectors for hazardous areas
- Water and dustproof to IP68 when mated with compatible connector
- Positive fast-acting locking ring - can be turned with a gloved hand
- Plug or Socket
- 2, 3, 4, 5, 7, 10 Contact with leading Earth on 3, 4, 5, 7 Contact versions, trailing Neutral on 5 Contact version
- Screw Terminals
- Choice of cable acceptance 7mm-22mm diameter depending on part code (see data for details):
- EXP-09 part codes 7mm-15mm diameter
- EXP-A9 part codes (large cable version with strain relief clamp) 14mm-22mm diameter
- Packs of Cable Glands for differing cable diameters available separately (EXP-0980, EXP-A980)
- EXP-0990 heavy duty Sealing Cap available separately to maintain IP rating of unmated connectors
- Mate with EXP-09 or EXP-A9 Series Flex and Panel Mounting Connectors, as appropriate

### // General Information:

Product Display Title:	Flex Cable Connectors for hazardous areas
Product Family:	Circular Power Connectors
Product Series:	EXPLora
Approvals:	UL
Body Material:	Polyester (PET)
Body Material Type:	Plastic Body
Contact Type:	Plug Contact
Coupling Type:	Screw
Current Max:	18A
Diameter Over Coupling Ring Mm:	58mm
Flamability Rating:	UL94V-0
Function:	Flex Cable Connector
Ip Rating:	IP68
Max Cable Entry Size:	22mm
Min Cable Entry Size:	20mm
Max Contact Accomodation Awg:	14AWG
Min Contact Accomodation Awg:	10AWG
Max Contact Accomodation Mm2:	4mm2
Min Contact Accomodation Mm2:	2.5mm2
Max Operating Temperature:	+55°C
Min Operating Temperature:	-20°C
Number Of Contacts:	5 Contacts
Voltage Max:	600V

#### // Product PDF Links

[EXP-lora Series power connectors...](#)

#### // Product 3D CAD Model Links

[EXP-A911/05/P3D CAD Model](#)