

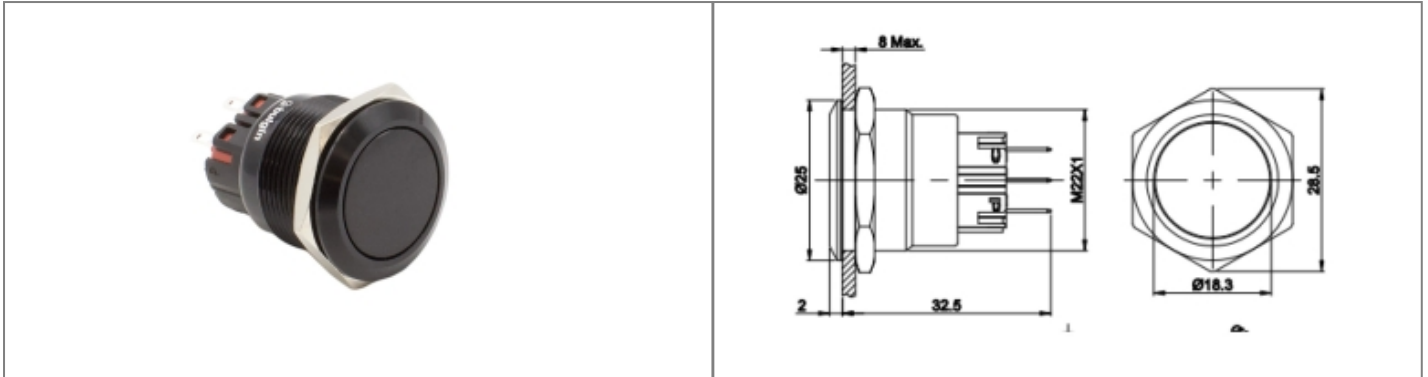





**Product Name // MP22SLNINRN000A5 Non Illuminated  
Vandal Resistant Switch**
[View Product Page](#)

**// Product Description:**

-  MP22 Series
-  SPDT
-  Latching
-  Not Illuminated
-  AL alloy Black
-  IP65

**// General Information:**

Product Display Title:	Non Illuminated Vandal Resistant Switch
Product Family:	Switch Range
Product Series:	Vandal Resistant Switches
Bezel Finish:	Gloss
Body Colour:	Black
Body Material:	Aluminium
Body Material Type:	Metal
Current Rating:	5A 250V
Diameter:	22mm
Dielectric Withstanding Voltage:	1500V
Durability:	50,000
Function:	Push Button Switch
Illumination Colour:	Not Illuminated
Illumination Shape:	Not Illuminated
Illumination Voltage:	Not Illuminated
Ip Rating:	IP65
Lamp Type:	Not Illuminated
Material Finish:	Gloss
Max Operating Temperature:	55°C
Min Operating Temperature:	-25°C
Max Panel Thickness:	8mm
Operating Humidity:	45~85 RH(Non condensing)
Panel Cut Out:	22mm Diameter circle
Rohs Compliant:	Yes
Switch Body Colour:	Black
Switch Body Material:	Aluminium
Switch Button Colour:	Black
Switch Button Material:	Aluminium
Switch Circuit:	SPDT
Switch Series:	MP22
Switch Shape:	Round
Switch Type:	Pushbutton
Switching Type:	Latching
Thread Size:	M22

**// Product PDF Links**
[22mm Vandal Resistant Switch](#)
**// Product 3D CAD Model Links**
[MP22SLNINRN000A53D CAD Model](#)

 Have a question or project enquiry  
you'd like to talk to us about?

[Click Here To Contact Us](#)