

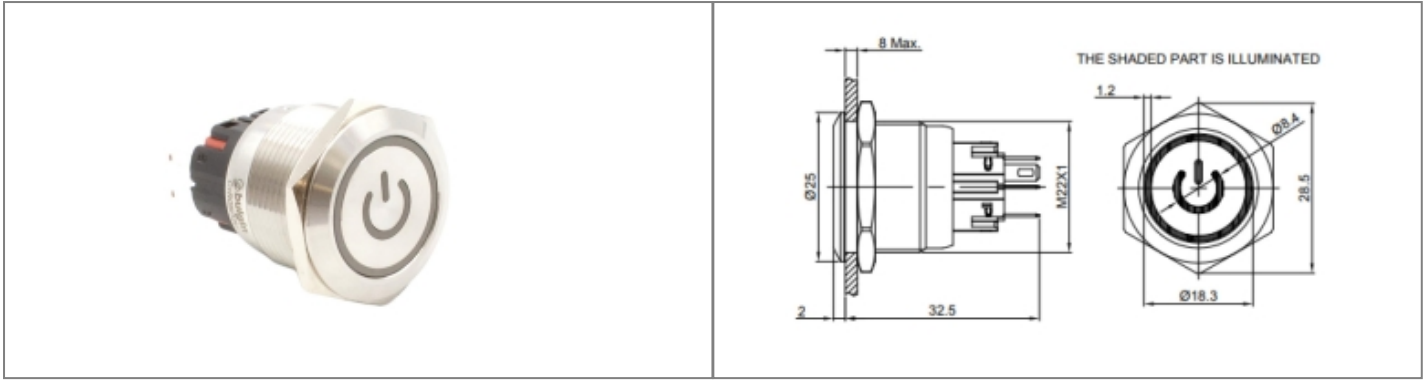







**Product Name // MP22SLPINRG024A5 Power Symbol  
Illumination Vandal Resistant Switch**
 [View Product Page](#)

**// Product Description:**

- |   |  |
|---|--|
|  MP22 Range                  |  Green            |
|  SPDT                       |  24V             |
|  Latching                  |  AL alloy Black |
|  Power Symbol Illumination |  IP65           |

**// General Information:**

Product Display Title:	Power Symbol Illumination Vandal Resistant Switch
Product Family:	Switch Range
Product Series:	Vandal Resistant Switches
Bezel Finish:	Gloss
Body Colour:	Black
Body Material:	Aluminium
Body Material Type:	Metal
Current Rating:	5A 250V
Diameter:	22mm
Dielectric Withstanding Voltage:	1500V
Durability:	50,000
Function:	Push Button Switch
Illumination Colour:	Green
Illumination Shape:	Power Symbol
Illumination Voltage:	24V
Ip Rating:	IP65
Lamp Type:	LED
Material Finish:	Gloss
Max Operating Temperature:	55°C
Min Operating Temperature:	-25°C
Max Panel Thickness:	8mm
Operating Humidity:	45~85 RH(Non condensing)
Panel Cut Out:	22mm Diameter circle
Rohs Compliant:	Yes
Switch Body Colour:	Black
Switch Body Material:	Aluminium
Switch Button Colour:	Black
Switch Button Material:	Aluminium
Switch Circuit:	SPDT
Switch Series:	MP22
Switch Shape:	Round
Switch Type:	Pushbutton
Switching Type:	Latching
Thread Size:	M22

**// Product PDF Links**
 [22mm Vandal Resistant Switch](#)
**// Product 3D CAD Model Links**
 [MP22SLPINRG024A53D CAD Model](#)