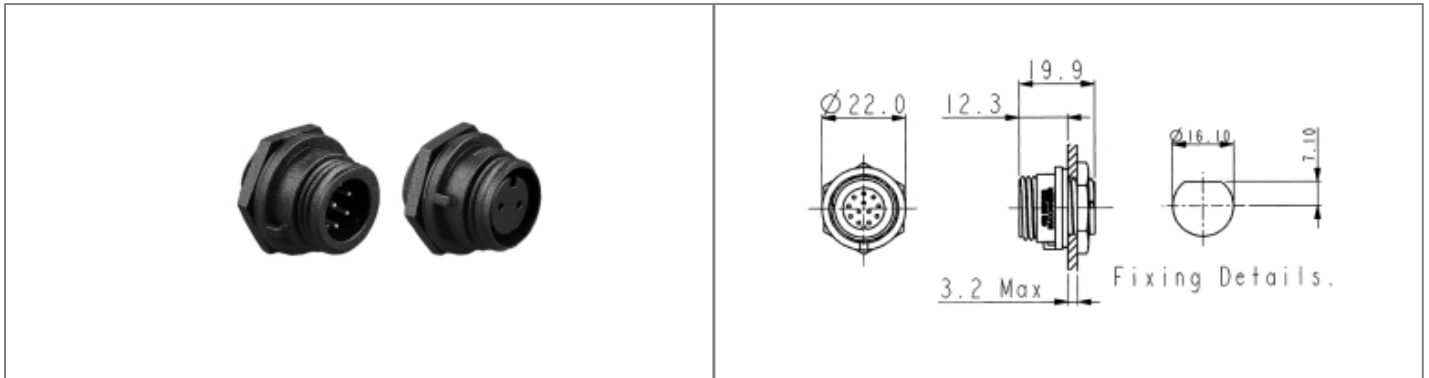

PX0412/04P Datasheet

Product Name // Front Panel Mount Connector Body PX0412 Series 4 Contact Plug

[View Product Page](#)

// Product Description:

- ⊕ Front Panel Mount Connector
- ⊕ Water and dustproof to IP68 when mated with compatible connector
- ⊕ Single hole fixing
- ⊕ Pin or Socket
- ⊕ 2, 3, 4, 6, 8, 10 or 12 Contact
- ⊕ Crimp or Solder Contacts available (supplied separately)
- ⊕ Contact insertion and crimp tools available (supplied separately)
- ⊕ PX0480 Sealing Cap available separately to maintain IP rating of unmated connectors
- ⊕ Mate with Flex Cable Connectors PX0400, PX0402, PX0410

// General Information:

Product Display Title:	Front Panel Mount Connector
Product Family:	Circular Power Connectors
Product Series:	400 Series Buccaneer
Approvals:	CSA, UL, VDE
Body Material:	Polyamide (PA)
Body Material Type:	Plastic Body
Contact Type:	Plug Contact
Coupling Type:	Screw
Current Max:	5A
Diameter Over Coupling Ring Mm:	19.1mm
Flamability Rating:	UL94V-0
Function:	Front Panel Mount Connector Body
Ip Rating:	IP68, IP69K
Max Operating Temperature:	+80°C
Min Operating Temperature:	-40°C
Number Of Contacts:	4 Contacts
Voltage Max:	125V

// Product PDF Links

[400 Series power connectors...](#)

// Product 3D CAD Model Links

[PX0412/04P3D CAD Model](#)

// Product Certificate Links

[UL Certificate - 400 series](#)
[CSA Standard - 400 Series...](#)
[VDE Certificate - 400 Series...](#)
[IP Certificate - 400 Series...](#)
[CE Certificate - 400 series and...](#)