

# PX0477/C/A/5M00 Datasheet

**Product Name // 400 Series USB-C Cable Assembly, Flex  
USB-C To USB-A, 5m**

 [View Product Page](#)

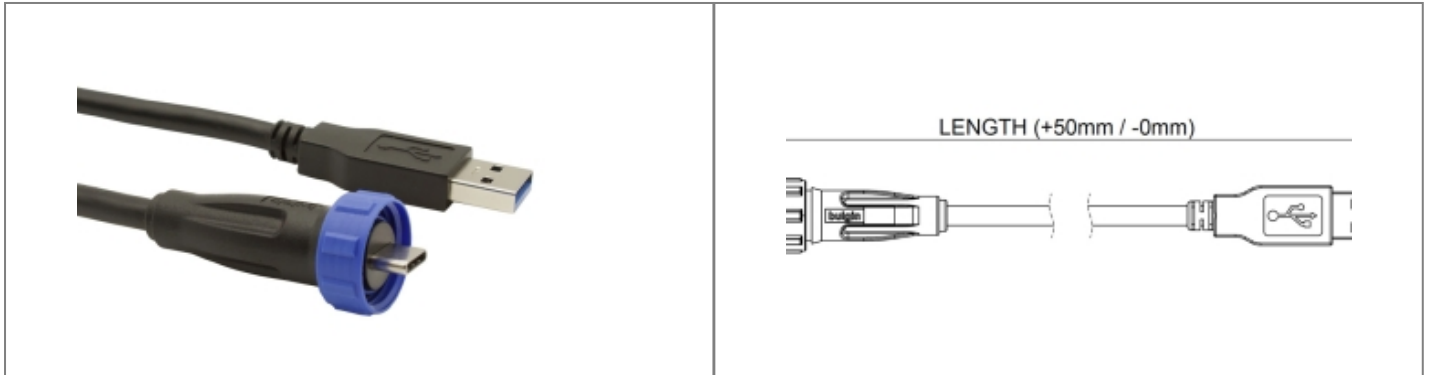

## // Product Description:

-  Overmoulded C-Type USB 3.2 Gen 2 Cable
-  Standard USB Type A plug to Sealed C-Type USB plug
-  USB-C end sealed to IP68 when mated with compatible connector
-  5m cable length
-  5Gbps transfer speed, 1A charging
-  PX0485 Sealing Cap available separately to maintain IP rating of unmated connectors
-  Mates with PX0472 and PX0473 panel mount connectors

## // General Information:

Product Display Title:	IP-sealed 'C' type to Standard 'A' type USB, 5m of Cable
Product Family:	Circular Data Connectors
Product Series:	400 Data Connectors
Body Material:	PVC/Nylon
Body Material Type:	Plastic Body
Cable Length:	5m
Contact Type:	Plug Contact
Coupling Type:	Screw
Flamability Rating:	UL94V-0
Function:	Flex to Standard Connector Double-Ended Cable
Ip Rating:	IP67, IP68
Max Operating Temperature:	+70°C
Min Operating Temperature:	-35°C
Number Of Contacts:	24 Contacts

### // Product PDF Links

 [400 Series C Type USB Buccaneer...](#)

### // Product 3D CAD Model Links

 [PX0477/C/A/5M003D CAD Model](#)