

PX0777/6Contact/05 Datasheet

Product Name // In-Line Sealed Cable Joiner PX0777
Series 6 Way Terminal Block 5mm-7mm Cable Black

 [View Product Page](#)

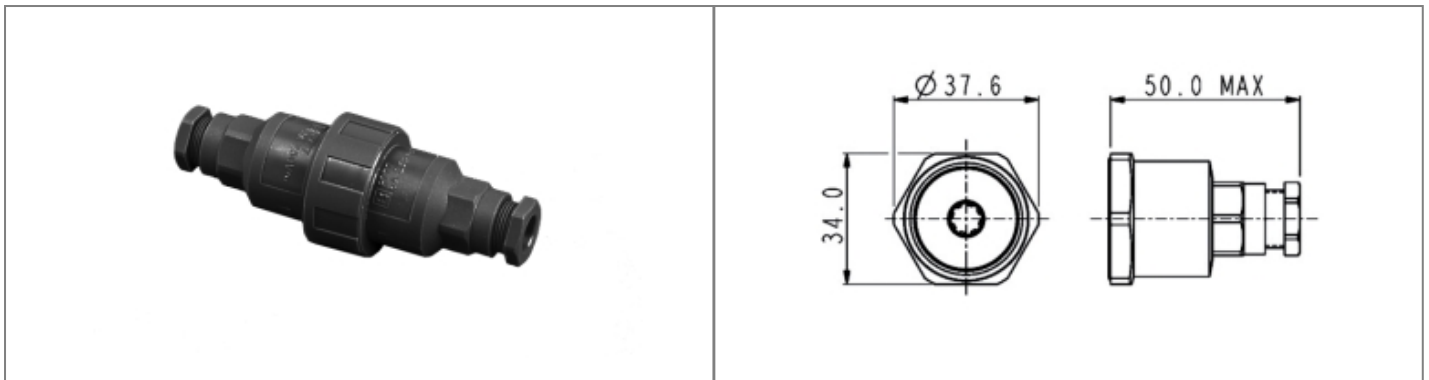

// Product Description:

- ⊕ Sealed In-Line Cable Joiner
- ⊕ Water and dustproof to IP68 when mated with compatible connector
- ⊕ Supplied with 3, 4, 6 or 8 way Terminal Block (for Power connections) or UTP/STP Coupler (for Ethernet connections)
- ⊕ Data connector available with Unshielded (UTP), Shielded (STP) and CAT5e Shielded Couplers
- ⊕ Data connector supplied with three Cable Glands in sizes: 3.5mm-5mm (blue), 5mm-7mm (green), 6mm-8mm (red)
- ⊕ Choice of cable acceptance for Power connector 3.5mm-9mm diameter depending on part code (see data for details)
- ⊕ Cable Glands for differing cable diameters available separately individually or in packs
- ⊕ Choice of body colour depending on part code:
- ⊕ Part codes with suffix /OR - Orange
- ⊕ Part codes with no suffix - Black

// General Information:

Product Display Title:	Sealed In-Line Cable Joiner
Product Family:	Circular Power Connectors
Product Series:	Standard Buccaneer
Body Colour:	Black
Body Material:	Polyamide (PA)- Glass Filled
Contact Type:	Terminal Block
Coupling Type:	Screw
Current Max:	10A
Diameter Over Coupling Ring Mm:	38.1mm
Flamability Rating:	UL94V-0
Function:	Flex to Inline Sealed Cable Joiner
Ip Rating:	IP68, IP69K
Max Cable Entry Size:	7mm
Min Cable Entry Size:	5mm
Max Operating Temperature:	+70°C
Min Operating Temperature:	-20°C
Number Of Contacts:	6 Contacts
Voltage Max:	250V

// Product PDF Links

 [Standard Series power connectors...](#)

// Product 3D CAD Model Links

 [PX0777/6Contact/053D CAD Model](#)