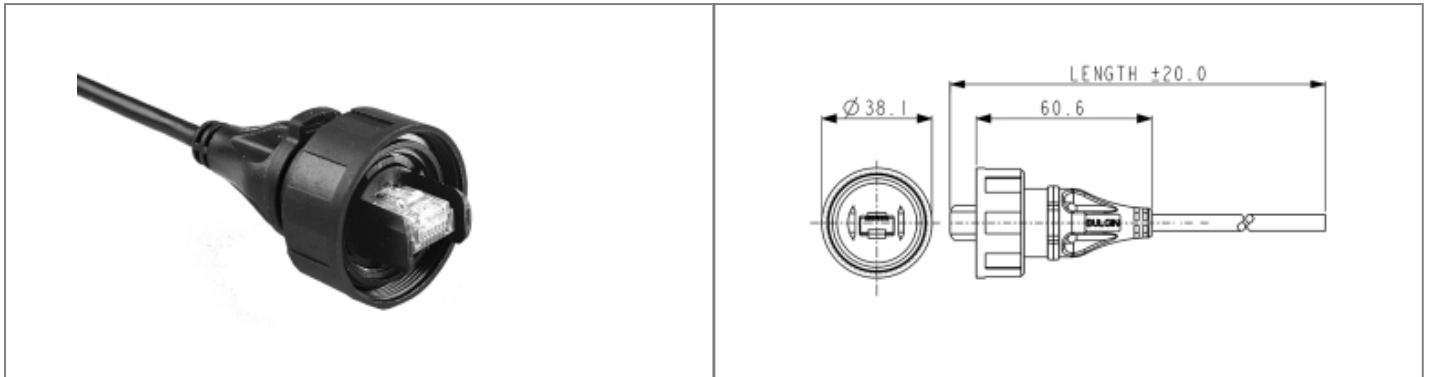

PX0836/5M00 Datasheet

Product Name // Overmould Flex Connector PX0836 Series Pre-Wired Patch Cord IP68 RJ45 to Bare End 5M Cable

[View Product Page](#)

// Product Description:

- ⊗ Cat 5e and Cat 6a Options
- ⊗ Pre-Wired Patch Cord with overmoulded connector(s)
- ⊗ Water and dustproof to IP68 when mated with compatible connector
- ⊗ Supplied with shielded RJ45 plug
- ⊗ S-FTP cable construction
- ⊗ PUR jacket cable in a choice of lengths depending on part code suffix
- ⊗ Choice of:
 - ⊗ IP68 RJ45 to bare end (part codes prefixed PX0836, PX0896)
 - ⊗ IP68 RJ45 to Shielded RJ45 (part codes prefixed PX0837, PX0897)
 - ⊗ IP68 RJ45 to IP68 RJ45 (part codes prefixed PX0838, PX0898)
 - ⊗ PX0835 Sealing Cap available separately to maintain IP rating of unmated connectors
 - ⊗ Mate with all PX08 Standard Series RJ45 Panel Mount Connectors

// General Information:

Product Display Title:	Cat 5e and Cat 6a Options
Product Family:	Circular Data Connectors
Product Series:	Standard Buccaneer - Ethernet
Body Material:	PVC
Contact Type:	Plug Contact
Coupling Type:	Screw
Current Max:	1.5A
Data Cable Type:	IP68 RJ45 to Bare End
Diameter Over Coupling Ring Mm:	38.1mm
Flamability Rating:	UL94V-0
Function:	Flex Connector Single Ended Cable
Ip Rating:	IP68, IP69K
Max Operating Temperature:	+70°C
Min Operating Temperature:	-20°C
Number Of Contacts:	8 Contacts
Voltage Max:	42V

// Product PDF Links

[Standard Series Ethernet...](#)

// Product 3D CAD Model Links

[PX0836/5M003D CAD Model](#)

Have a question or project enquiry
you'd like to talk to us about?



[Click Here To Contact Us](#)