

PX0848/A3 Datasheet

Product Name // Rear Panel Mount Connector PX0848
Series USB 3.0 Sealed A Socket Front of Panel to Standard A Socket Rear of Panel

 [View Product Page](#)

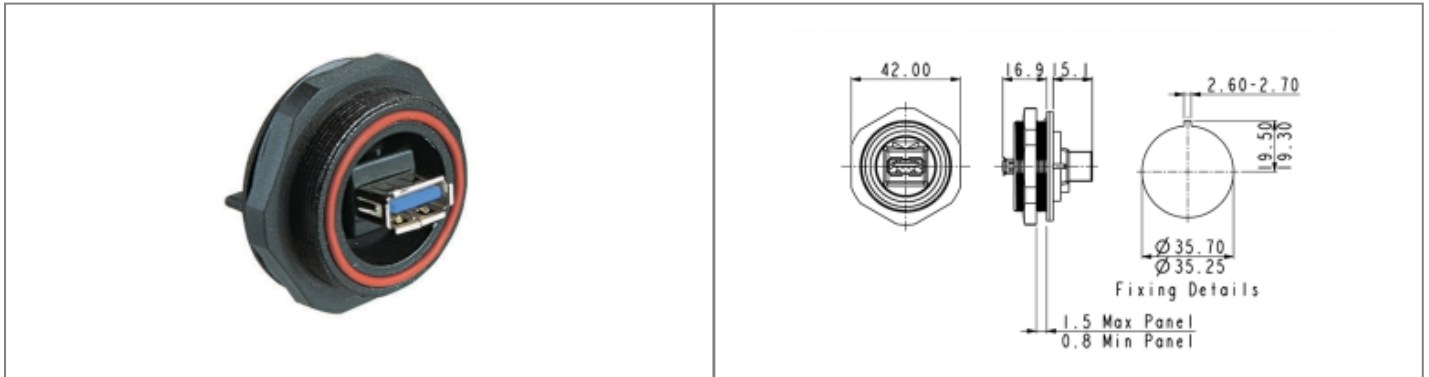

// Product Description:

- ⊕ Rear Panel Mounting Connector
- ⊕ Water and dustproof to IP68 when mated with compatible connector
- ⊕ Sealed Standard USB 3.0 Type A socket on external/front panel face, Standard USB 3.0 Type A socket on internal/rear panel face
- ⊕ PX0711 Sealing Cap available separately to maintain IP rating of unmated connectors
- ⊕ Mate with PX0840, PX0841 USB Cables

// General Information:

Product Display Title:	Rear Panel Mount Connector
Product Family:	Circular Data Connectors
Product Series:	Standard Buccaneer - USB
Body Colour:	Black
Body Material:	Polyester (PE) - Glass Filled
Body Material Type:	Plastic Body
Contact Type:	Socket Contact
Coupling Type:	Screw
Current Max:	1A
Data Cable Type:	USB 3.0 Sealed A Socket to Standard A Socket
Diameter Over Coupling Ring Mm:	38.1mm
Flamability Rating:	UL94V-0
Function:	Rear Panel Mount Connector
Ip Rating:	IP68, IP69K
Max Operating Temperature:	+70°C
Min Operating Temperature:	0°C
Number Of Contacts:	9 Contacts
Rohs Compliant:	Yes
Voltage Max:	5V

// Product PDF Links

 [Standard Series USB connectors...](#)

// Product 3D CAD Model Links

 [PX0848/A33D CAD Model](#)