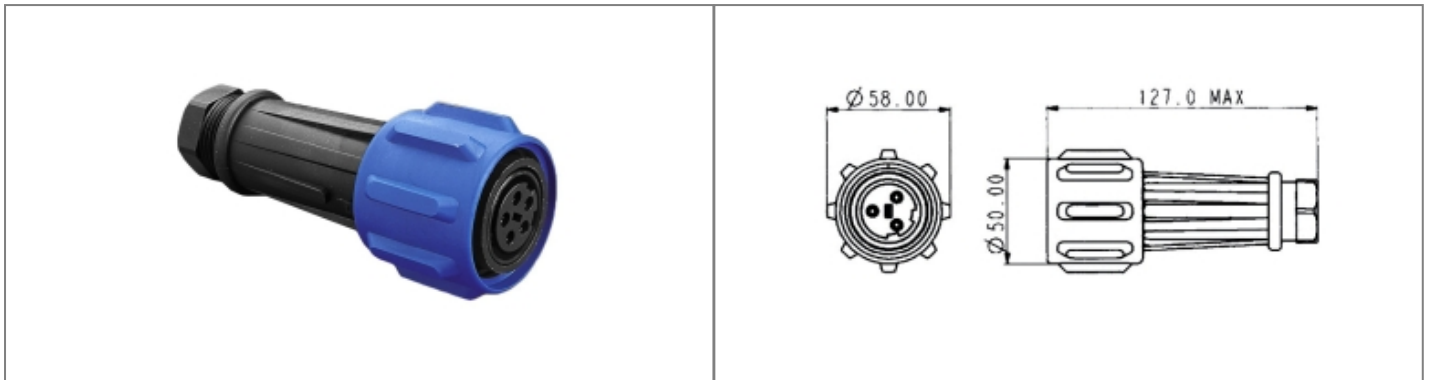

PX0911/03/S Datasheet

Product Name // Flex Cable Connector PX0911 Series 3 Contact Socket 13mm-15mm Cable (Yellow Gland)

[View Product Page](#)

// Product Description:

- ⊕ Flex Cable Connectors
- ⊕ Water and dustproof to IP68 when mated with compatible connector
- ⊕ Positive fast-acting locking ring - can be turned with a gloved hand
- ⊕ Plug or Socket
- ⊕ 2, 3, 4, 5, 7, 10 Contact with leading Earth on 3, 4, 5, 7 Contact versions, trailing Neutral on 5 Contact version
- ⊕ Screw Terminals
- ⊕ Choice of cable acceptance 7mm-22mm diameter depending on part code (see data for details):
- ⊕ PX09 part codes 7mm-15mm diameter
- ⊕ PXA9 part codes (large cable version with strain relief clamp) 14mm-22mm diameter
- ⊕ Packs of Cable Glands for differing cable diameters available separately (PX0980, PXA980)
- ⊕ PX0960/PX0990 Sealing Caps available separately to maintain IP rating of unmated connectors
- ⊕ Mate with PX09 or PXA9 Series Flex and Panel Mount Connectors, as appropriate

// General Information:

Product Display Title:	Flex Cable Connectors
Product Family:	Circular Power Connectors
Product Series:	900 Series Buccaneer
Approvals:	UL
Body Material:	Polyamide (PA)
Body Material Type:	Plastic Body
Contact Type:	Socket Contact
Coupling Type:	Screw
Current Max:	32A
Diameter Over Coupling Ring Mm:	58mm
Flamability Rating:	UL94V-0
Function:	Flex Cable Connector
Ip Rating:	IP68
Max Cable Entry Size:	15mm
Min Cable Entry Size:	13mm
Max Contact Accomodation Awg:	13AWG
Min Contact Accomodation Awg:	10AWG
Max Contact Accomodation Mm2:	4mm ²
Min Contact Accomodation Mm2:	2.6mm ²
Max Operating Temperature:	+85°C
Min Operating Temperature:	-40°C
Number Of Contacts:	3 Contacts
Voltage Max:	600V

// Product PDF Links

[900 Series power connectors...](#)
[900 Series power connectors wiring...](#)

// Product 3D CAD Model Links

[PX0911/03/S3D CAD Model](#)