

PX0941/04/P Datasheet

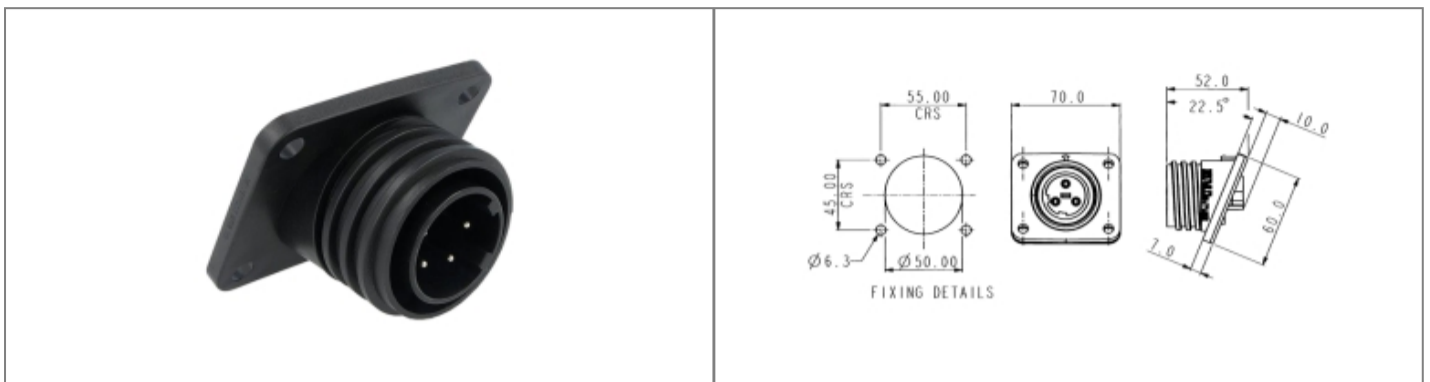









Product Name // Flange Mount Connector PX0941 Range 4

Contact Plug

 [View Product Page](#)



// Product Description:

-  Flange Mount Connector
-  Water and dustproof to IP68 when mated with compatible connector
-  Positive fast-acting locking ring - can be turned with a gloved hand
-  Plug or Socket
-  2, 3, 4, 5, 7, 10 Contact with leading Earth on 3, 4, 5, 7 Contact versions, trailing Neutral on 5 Contact version
-  Supplied with high grade sealing gasket
-  Supplied with sealing grommets for panel fixing screws (M6 thread recommended)
-  Additional Bulkhead Adaptor Moulding available separately (PX0950) to enable connector angle of 45 or 90 degrees
-  PX0970/PX0992 Sealing Cap available separately to maintain IP rating of unmated connectors
-  Mate with PX0911 and PXA911 Series Flex Connectors

// General Information:

Product Display Title:	Flange Mount Connector
Product Family:	Circular Power Connectors
Product Series:	900 Series Buccaneer
Approvals:	CSA
Body Material:	Polyamide (PA)
Body Material Type:	Plastic Body
Contact Type:	Plug Contact
Coupling Type:	Screw
Current Max:	25A
Diameter Over Coupling Ring Mm:	58mm
Flamability Rating:	UL94V-0
Function:	Flange Mount Connector
Ip Rating:	IP68
Max Contact Accomodation Awg:	14AWG
Min Contact Accomodation Awg:	10AWG
Max Contact Accomodation Mm2:	4mm2
Min Contact Accomodation Mm2:	2.5mm2
Max Operating Temperature:	+85°C
Min Operating Temperature:	-40°C
Number Of Contacts:	4 Contacts
Voltage Max:	600V

// Product PDF Links

 [900 Series power connectors...](#)

 [900 Series power connectors wiring...](#)

// Product 3D CAD Model Links

 [PX0941/04/P3D CAD Model](#)