

PXEB5213C002 Datasheet

Product Name // 2 Channel Jam Nut to SC Connector Cable Assembly

[View Product Page](#)

* Representative product image only

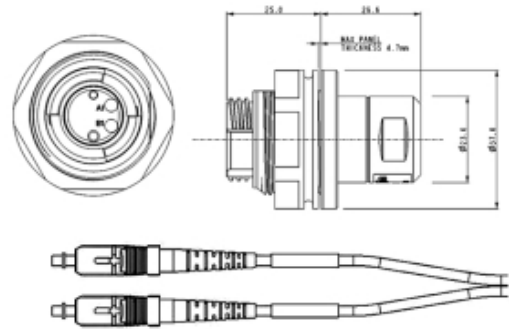

// Product Description:

- ⊞ A Terminated Jam Nut Bulkhead (JNBH) Connector with 2 (OM3) SC terminated independent cables - 2m Long Cable Assembly
- ⊞ Designed to MIL-DTL83526D
- ⊞ Compatible with any connector that follows MIL-DTL83526D
- ⊞ Dust Cap for all Connectors & Jam Nut Lanyard Included
- ⊞ Mates with Plug Connectors (hermaphroditic)
- ⊞ Operating Temperature -50°C to +80°C
- ⊞ Available in 4 Channel
- ⊞ Available in Jam Nut to LC Cable Assembly

// General Information:

Product Display Title:	2 Channel Jam Nut to SC Connector Cable Assembly
Product Family:	Circular Fiber Connectors
Product Series:	5000 Series Expanded Beam
Max Insertion Loss:	<2dB
Avg Insertion Loss:	<1.5dB
Body Colour:	Dark Grey
Body Material:	Polycarbonate/Polybutylene Terephthalate (PC/PBT)
Body Material Type:	Plastic Body
Contact Type:	Expanded Beam
Coupling Nut Retention Force:	1Nm
Coupling Type:	Screw
Diameter Over Coupling Ring Mm:	30mm
Fibre Mode:	OM3
Flamability Rating:	UL94V-0
Function:	EB Jam Nut to SC Double Ended Fiber Cable
Ip Rating:	IP68
Material Finish:	Matt
Max Operating Temperature:	+80°C
Min Operating Temperature:	-50°C
Max Panel Thickness:	4.7mm
Rohs Compliant:	Yes

// Product PDF Links

[5000 Series Expanded Beam Product...](#)

// Product 3D CAD Model Links

[PXEB5213C0023D CAD Model](#)

Have a question or project enquiry
you'd like to talk to us about?



[Click Here To Contact Us](#)