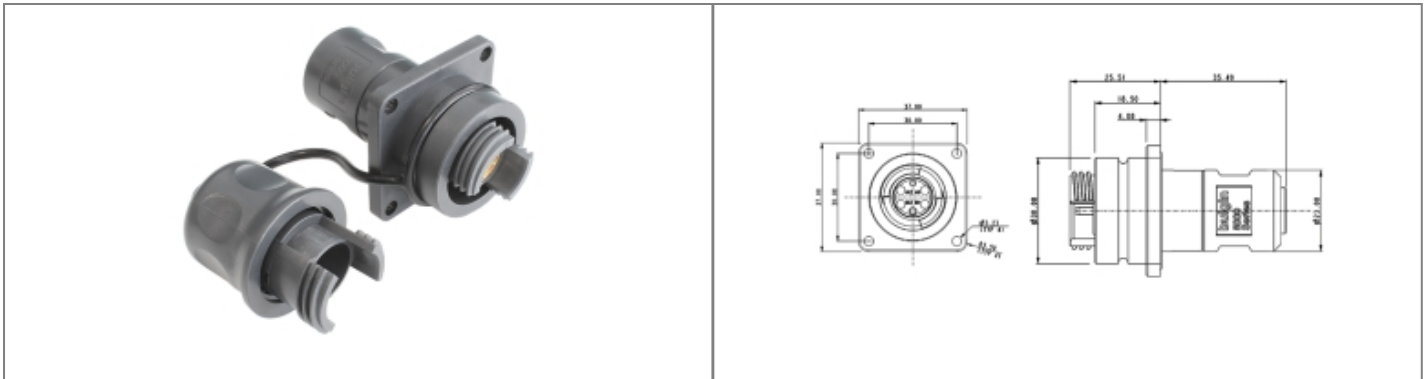

# PXEB5420MM5560 Datasheet

## Product Name // 4 Channel Flange Mount Bulkhead Connector with Cable Retention

[View Product Page](#)

### // Product Description:

- ⊞ Non-terminated Flange Mount Bulkhead Connector for a 4-Channel Multimode Cable with 5.5-6mm Diameter
- ⊞ Designed to MIL-DTL83526D
- ⊞ Compatible with any connector that follows MIL-DTL83526D
- ⊞ Compatible with OM1 & OM3
- ⊞ Dust Cap, Lanyard, and Ferrules (termini) for the Cable Included
- ⊞ Mates with Plug Connectors (hermaphroditic)
- ⊞ Operating Temperature -50°C to +80°C
- ⊞ Available in 2 Channel

### // General Information:

Product Display Title:	4 Channel Flange Mount Bulkhead Connector with Cable Retention
Product Family:	Circular Fiber Connectors
Product Series:	5000 Series Expanded Beam
Max Insertion Loss:	<2dB
Avg Insertion Loss:	<1.5dB
Body Colour:	Dark Grey
Body Material:	Polycarbonate/Polybutylene Terephthalate (PC/PBT)
Body Material Type:	Plastic Body
Contact Type:	Expanded Beam
Coupling Type:	Screw
Diameter Over Coupling Ring Mm:	30mm
Fibre Mode:	MM
Flamability Rating:	UL94V-0
Function:	EB Flange Mount Bulkhead Connector
Ip Rating:	IP68
Material Finish:	Matt
Max Cable Entry Size:	6mm
Min Cable Entry Size:	5.5mm
Max Operating Temperature:	+80°C
Min Operating Temperature:	-50°C
Rohs Compliant:	Yes

#### // Product PDF Links

[5000 Series Expanded Beam Product...](#)

#### // Product 3D CAD Model Links

[PXEB5420MM55603D CAD Model](#)