

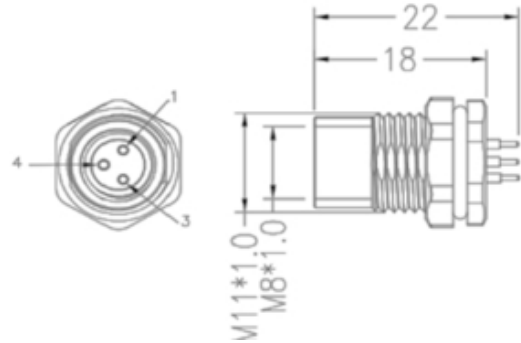







Product Name // PXMBNI08RPF06AFLM8001
 [View Product Page](#)

// Product Description:

-  Material=Metal
-  Pins=4
-  Max Rating=30Vac
-  Ingress Protection=IP67
-  Operating Temperature= -25°C to +85°C
-  Contact Resistance=5?
-  Insulation Resistance=>100M?
-  Mechanical Cycles=100 (min)

// General Information:

Product Display Title:	M8 Series Rear Panel Mount Connectors
Product Family:	Circular Automation Connectors
Product Series:	M8 Series
Body Material:	Brass - Nickel Plated
Contact Type:	Socket Contact
Number Of Contacts:	6 Contacts

// Product PDF Links
 [M8 Series automation connectors...](#)
// Product 3D CAD Model Links
 [PXMBNI08RPF06AFLM80013D CAD Model](#)