

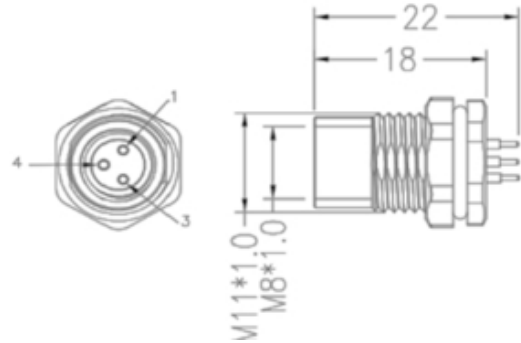







Product Name // PXMBNI08RPF08AFLM8002
 [View Product Page](#)

// Product Description:

-  Material=Metal
-  Pins=4
-  Max Rating=60Vac
-  Ingress Protection=IP67
-  Operating Temperature= -25°C to +85°C
-  Contact Resistance=5?
-  Insulation Resistance=>100M?
-  Mechanical Cycles=100 (min)

// General Information:

Product Display Title:	M8 Series Rear Panel Mount Connectors
Product Family:	Circular Automation Connectors
Product Series:	M8 Series
Body Material:	Brass - Nickel Plated
Contact Type:	Socket Contact
Number Of Contacts:	8 Contacts

// Product PDF Links
 [M8 Series automation connectors...](#)
// Product 3D CAD Model Links
 [PXMBNI08RPF08AFLM80023D CAD Model](#)

Have a question or project enquiry
you'd like to talk to us about?



[Click Here To Contact Us](#)