

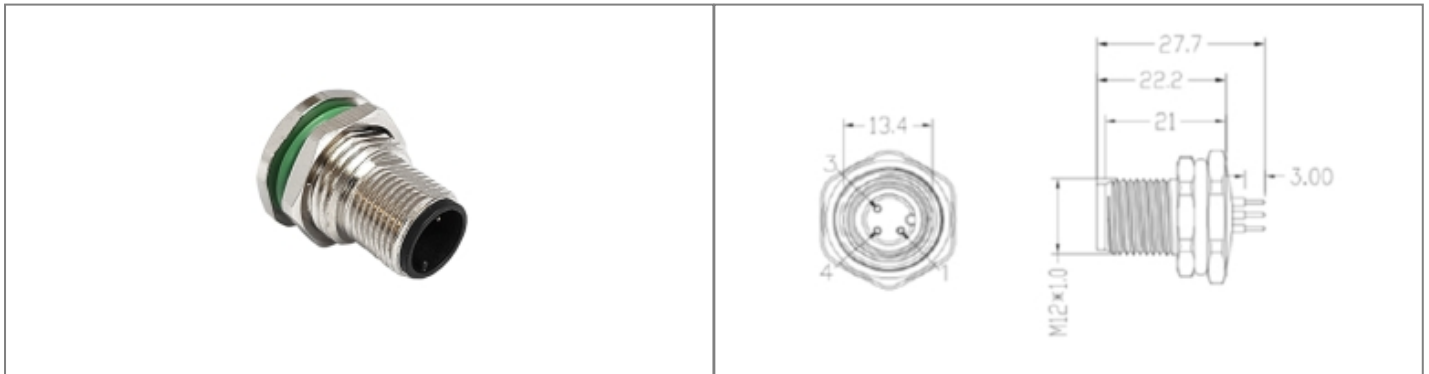







**Product Name // M12 Series A Code Brass Nickel Plated
PG9 Rear Panel Mount Connector 8 Contact Pins PCB
Termination**

 [View Product Page](#)



// Product Description:

-  M12 Series Rear Panel Mount Connectors
-  Water and dustproof to IP67 when mated with compatible connector
-  Pin or Socket
-  3, 4, 5, 8, 12 Contact (3, 8, 12 Contact are A Code, 4 Contact are choice of A Code or D Code, 5 Contact are choice of A Code or B Code)
-  PCB Terminals
-  Choice of mounting nut sizes, depending on part code
-  Choice of Sealing Caps available separately to maintain IP rating of unmated connectors
-  Mate with M12 Series Inline Body and Flex Body Connectors, depending on part code

// General Information:

Product Display Title:	M12 Series Rear Panel Mount Connectors
Product Family:	Circular Automation Connectors
Product Series:	M12 Series
Approvals:	CSA, UL
Body Material:	Brass - Nickel Plated
Contact Type:	Plug Contact
Coupling Type:	Screw
Current Max:	2A
Diameter Over Coupling Ring Mm:	20mm
Function:	Rear Panel Mount Connector
Ip Rating:	IP67
M12 Series Mounting Nut:	PG9
Max Operating Temperature:	+80°C
Min Operating Temperature:	-25°C
Number Of Contacts:	8 Contacts
Pin Layout Code:	A Code
Thread Size:	M12 x 1
Voltage Max:	30V

// Product PDF Links

 [M12 Series automation connectors...](#)

// Product 3D CAD Model Links

 [PXMBN12RPM08APCPG93D CAD Model](#)