

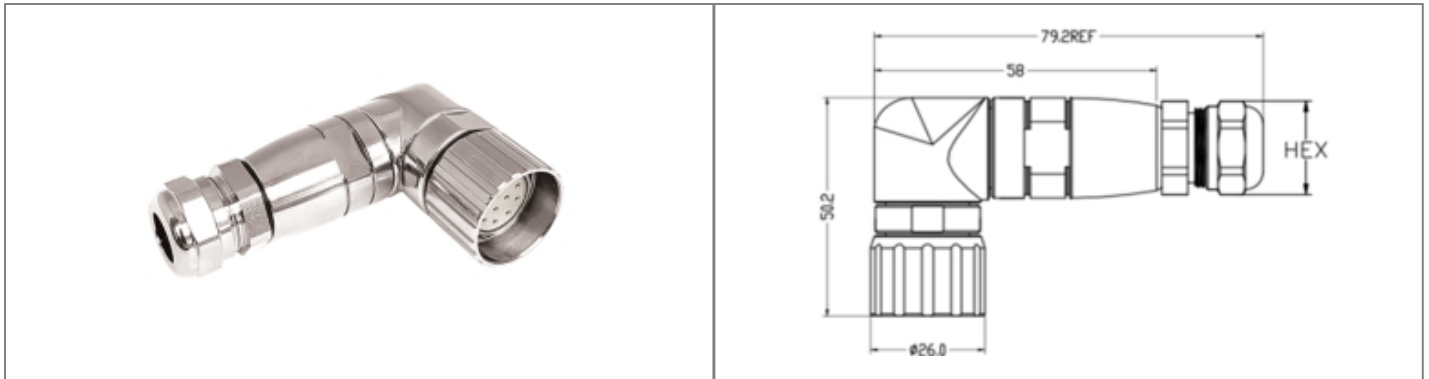







# PXMBNI23RAF12ASC Datasheet

**Product Name // M23 Series A Code Brass Nickel Plated  
PG9 Right-Angle Flex Body 12 Contact Socket**

 [View Product Page](#)



## // Product Description:

-  M23 Series Brass Nickel Plated Right-Angle Flex Body Connectors
-  Water and dustproof to IP67 when mated with compatible connector
-  A Code
-  Socket only
-  12, 19 Contact
-  Solder Terminals
-  Mate with M23 Series Panel Mount Connectors, depending on part code

## // General Information:

Product Display Title:	M23 Series Brass Nickel Plated Right-Angle Flex Body Connectors
Product Family:	Circular Automation Connectors
Product Series:	M23 Series
Change Notes:	PRODUCT-MOQ-ADJUSTMENT
Body Material:	Brass - Nickel Plated
Contact Type:	Socket Contact
Coupling Type:	Screw
Current Max:	8A
Diameter Over Coupling Ring Mm:	26mm
Function:	Right Angle Flex Female Connector Body
Ip Rating:	IP67
M12 Series Mounting Nut:	PG9
Max Operating Temperature:	+80°C
Min Operating Temperature:	-25°C
Number Of Contacts:	12 Contacts
Pin Layout Code:	A Code
Thread Size:	M23 x 1
Voltage Max:	200V

### // Product PDF Links

 [M23 Series automation connectors...](#)

### // Product 3D CAD Model Links

 [PXMBNI23RAF12ASC3D CAD Model](#)