

PXMBNI78FPF04AFLPG135005 Datasheet

**Product Name // 4 Contacts 7/8" Front Panel Mounting
Female 500mm Flying Leads**

[View Product Page](#)

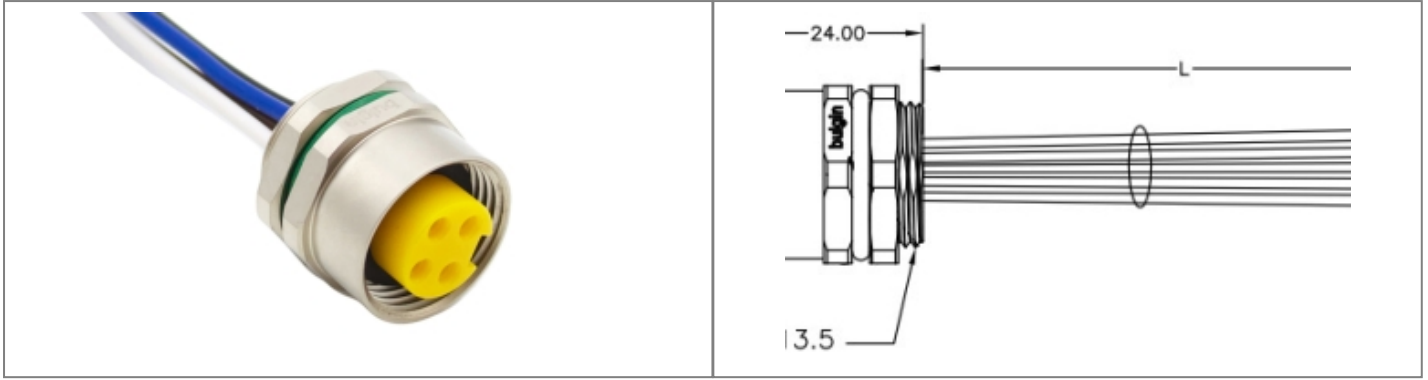

// Product Description:

- ⊕ 3 Contacts 7-8" Front Panel Mounting Female 0.5M Cable
- ⊕ IP67 rated when mated
- ⊕ Mechanical Cycles >100
- ⊕ Operating Temperature -25°C to +85°C
- ⊕ Rated Voltage 300 V
- ⊕ ROHS compliance

// General Information:

Product Display Title:	7/8" Front Panel Mounting Female 500mm Flying Leads
Product Family:	Circular Automation Connectors
Product Series:	7/8" Series
Cable Length:	0.5m
Connection Method:	Solder
Contact Type:	Socket Contact
Current Max:	8A
Durability:	>100 Cycles
Function:	Front Panel Mounting Female Connector with Flying Leads
Insulation Resistance:	>100MΩ
Ip Rating:	IP67
Max Operating Temperature:	+80°C
Min Operating Temperature:	-25°C
Number Of Contacts:	4 Contacts
Pin Layout Code:	A Code
Rohs Compliant:	Yes
Thread Size:	PG13.5
Voltage Max:	300V

// Product PDF Links

[78 Series Circular connectors...](#)

// Product 3D CAD Model Links

[PXMBNI78FPF04AFLPG1350053D CAD...](#)