

# PXP4000/002/02S Datasheet

**Product Name // Pre-wired Flex Cable Connector - 2m - 2  
Contacts - Socket**

 [View Product Page](#)

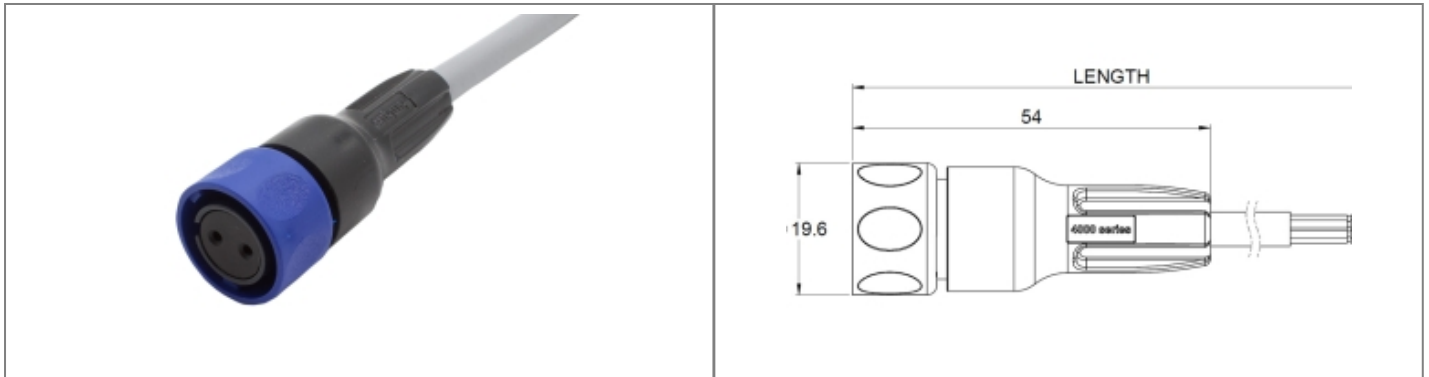

## // Product Description:

-  Pre-Wired Flex Cable Connector
-  Water and dustproof to IP68 when mated with compatible connector
-  4000 Series Buccaneer to blunt cut wire
-  2m Cable Length
-  2 Contacts - Socket
-  Sealing Cap available separately to maintain IP rating of unmated connectors
-  Mates with front and rear panel mounting connectors - and inline cable connectors

## // General Information:

Product Display Title:	Pre-Wired Flex Cable Connector
Product Family:	Circular Power Connectors
Product Series:	4000 Series Buccaneer
Approvals:	cUL, UL, VDE
Body Colour:	Black
Body Material:	Polyamide (PA)
Body Material Type:	Plastic Body
Cable Length:	2m
Contact Type:	Socket Contact
Coupling Type:	Bayonet Lock
Current Max:	13A
Diameter Over Coupling Ring Mm:	19.7mm
Flamability Rating:	UL94V-0
Function:	Flex Cable Connector
Ip Rating:	IP66, IP67, IP68
Max Operating Temperature:	+120°C
Min Operating Temperature:	-30°C
Number Of Contacts:	2 Contacts
Rohs Compliant:	Yes
Voltage Max:	600V

### // Product PDF Links

 [4000 Series power connectors...](#)

### // Product 3D CAD Model Links

 [PXP4000/002/02S3D CAD Model](#)