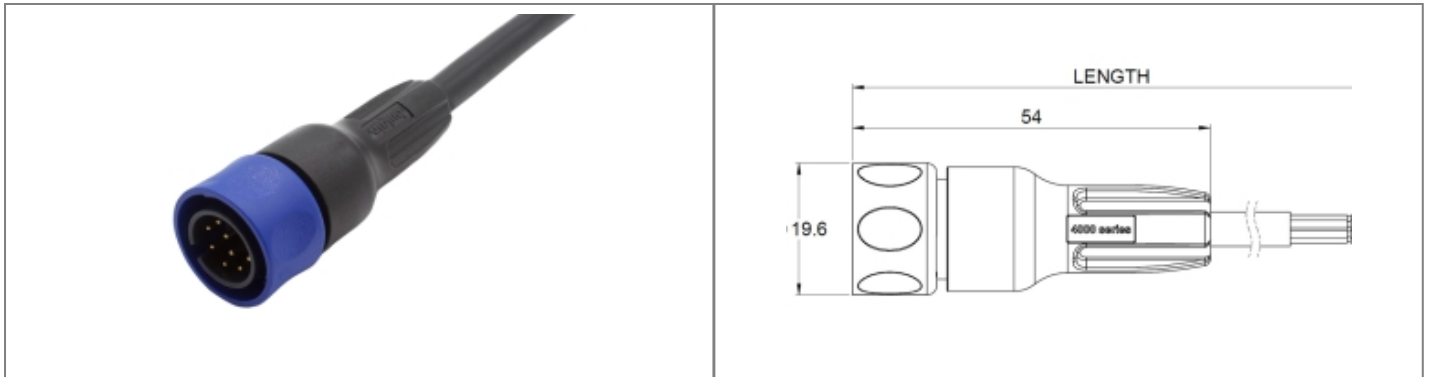

# PXP4000/010/08P Datasheet

## Product Name // Pre-wired Flex Cable Connector - 10m - 8 Contacts - Plug

[View Product Page](#)

### // Product Description:

- ⊞ Pre-Wired Flex Cable Connector
- ⊞ Water and dustproof to IP68 when mated with compatible connector
- ⊞ 4000 Series Buccaneer to blunt cut wire
- ⊞ 10m Cable Length
- ⊞ 8 Contacts - Plug
- ⊞ Sealing Cap available separately to maintain IP rating of unmated connectors
- ⊞ Mates with front and rear panel mounting connectors - and inline cable connectors

### // General Information:

Product Display Title:	Pre-Wired Flex Cable Connector
Product Family:	Circular Power Connectors
Product Series:	4000 Series Buccaneer
Approvals:	cUL, UL, VDE
Body Colour:	Black
Body Material:	Polyamide (PA)
Body Material Type:	Plastic Body
Cable Length:	10m
Contact Type:	Plug Contact
Coupling Type:	Bayonet Lock
Current Max:	8A
Diameter Over Coupling Ring Mm:	19.7mm
Flamability Rating:	UL94V-0
Function:	Flex Cable Connector
Ip Rating:	IP66, IP67, IP68
Max Operating Temperature:	+120°C
Min Operating Temperature:	-30°C
Number Of Contacts:	8 Contacts
Rohs Compliant:	Yes
Voltage Max:	300V

#### // Product PDF Links

[4000 Series power connectors...](#)

#### // Product 3D CAD Model Links

[PXP4000/010/08P3D CAD Model](#)