

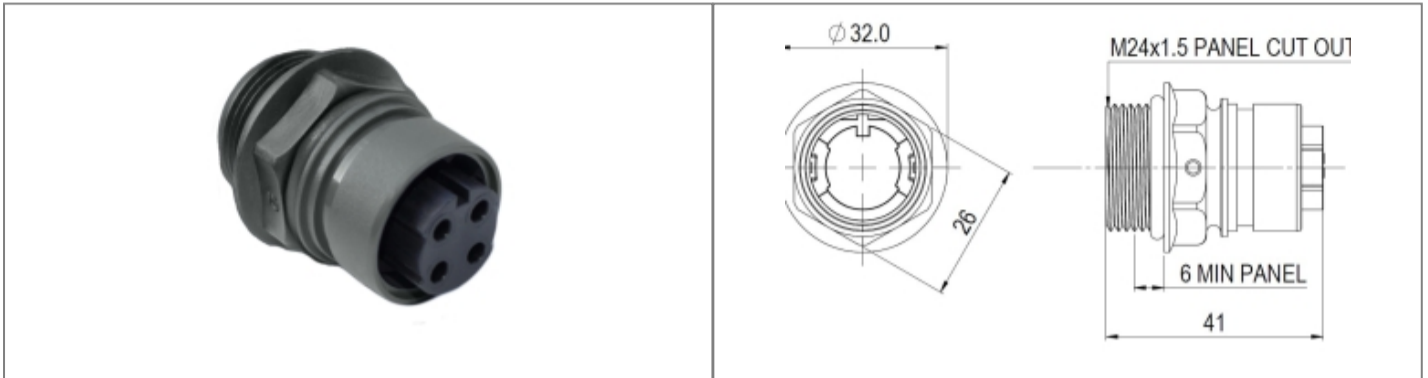









# PXP6014/02P/ST Datasheet

**Product Name // Screwed Front Panel Mount Connector**  
**PXM6014 Series 2 Contact Plug Screw Termination**  
**(contacts supplied fitted) Plastic Body**

 [View Product Page](#)



## // Product Description:

-  Screwed Front Panel Mount Connectors
-  Water and dustproof to IP66, IP68, IP69K when mated with compatible connector
-  30 degree push twist locking, tamperproof lock prevents accidental un-mating
-  Plug
-  2 Contacts
-  Screw contacts supplied fitted
-  Plastic Body
-  PXP6083 Sealing Cap available separately to maintain IP rating of unmated connectors
-  Mate with PXP6010 Series Flex Connectors

## // General Information:

|  |   |
|--|---|
| <b>Product Display Title:</b>          | Screwed Front Panel Mount Connectors                            |
| <b>Product Family:</b>                 | Circular Power Connectors                                       |
| <b>Product Series:</b>                 | 6000 Series Buccaneer   |
| <b>Body Colour:</b>                    | Grey  |
| <b>Body Material:</b>                  | Polycarbonate/Polybutylene Terephthalate (PC/PBT)               |
| <b>Body Material Type:</b>             | Plastic Body  |
| <b>Contact Type:</b>                   | Plug Contact  |
| <b>Coupling Type:</b>                  | Push-Twist  |
| <b>Diameter Over Coupling Ring Mm:</b> | 32mm  |
| <b>Flamability Rating:</b>             | UL94V-0   |
| <b>Function:</b>                       | Front Panel Mount Connector                                     |
| <b>Insulation Resistance:</b>          | >10 <sup>6</sup> MΩ @500V DC                                    |
| <b>Ip Rating:</b>                      | IP66, IP68, IP69K   |
| <b>Max Contact Accomodation Awg:</b>   | 16AWG   |
| <b>Min Contact Accomodation Awg:</b>   | 18AWG   |
| <b>Max Contact Accomodation Mm2:</b>   | 1.5mm <sup>2</sup>  |
| <b>Min Contact Accomodation Mm2:</b>   | 0.75mm <sup>2</sup>   |
| <b>Max Operating Temperature:</b>      | +120°C  |
| <b>Min Operating Temperature:</b>      | -40°C   |
| <b>Min Panel Thickness:</b>            | 6mm   |
| <b>Number Of Contacts:</b>             | 2 Contacts  |
| <b>Panel Cut Out:</b>                  | M24x1.5   |
| <b>Rohs Compliant:</b>                 | Yes   |
| <b>Salt Spray Corrosion Test:</b>      | EN60068-2-52 Test Kb Salt Mist (Cyclic) Marine Severity Level 1 |
| <b>Thread Size:</b>                    | M24x1.5   |
| <b>Voltage Max:</b>                    | 277V  |

### // Product PDF Links

 [6000 Series power connectors...](#)

 [6000 Series metal body power...](#)

### // Product 3D CAD Model Links

 [PXP6014/02P/ST3D CAD Model](#)