

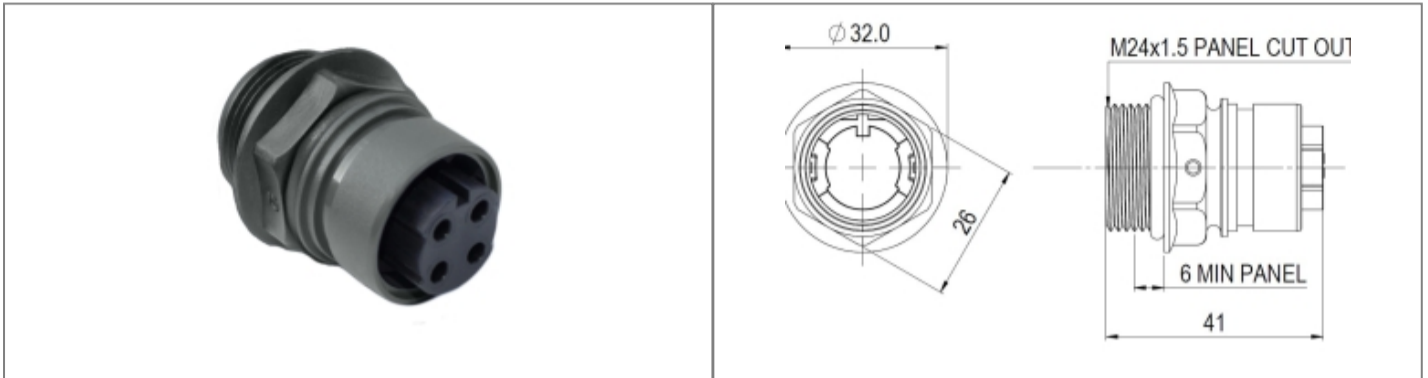









PXP6014/02S/CR Datasheet

Product Name // Screwed Front Panel Mount Connector
PXM6014 Series 2 Contact Socket Crimp/Solder
Termination (contacts available separately) Plastic Body

 [View Product Page](#)



// Product Description:

-  Screwed Front Panel Mount Connectors
-  Water and dustproof to IP66, IP68, IP69K when mated with compatible connector
-  30 degree push twist locking, tamperproof lock prevents accidental un-mating
-  Socket
-  2 Contacts
-  Crimp/solder termination with contacts and fitting tool available separately
-  Plastic Body
-  PXP6083 Sealing Cap available separately to maintain IP rating of unmated connectors
-  Mate with PXP6010 Series Flex Connectors

// General Information:

Product Display Title:	Screwed Front Panel Mount Connectors
Product Family:	Circular Power Connectors
Product Series:	6000 Series Buccaneer
Body Colour:	Grey
Body Material:	Polycarbonate/Polybutylene Terephthalate (PC/PBT)
Body Material Type:	Plastic Body
Contact Type:	Socket Contact
Coupling Type:	Push-Twist
Diameter Over Coupling Ring Mm:	32mm
Flamability Rating:	UL94V-0
Function:	Front Panel Mount Connector
Insulation Resistance:	>10 ⁶ MΩ @500V DC
Ip Rating:	IP66, IP68, IP69K
Max Contact Accomodation Awg:	14AWG
Min Contact Accomodation Awg:	18AWG
Max Contact Accomodation Mm2:	1.5mm ²
Min Contact Accomodation Mm2:	0.75mm ²
Max Operating Temperature:	+120°C
Min Operating Temperature:	-40°C
Min Panel Thickness:	6mm
Number Of Contacts:	2 Contacts
Panel Cut Out:	M24x1.5
Rohs Compliant:	Yes
Salt Spray Corrosion Test:	EN60068-2-52 Test Kb Salt Mist (Cyclic) Marine Severity Level 1
Thread Size:	M24x1.5
Voltage Max:	277V

// Product PDF Links

 [6000 Series power connectors...](#)

 [6000 Series metal body power...](#)

// Product 3D CAD Model Links

 [PXP6014/02S/CR3D CAD Model](#)