

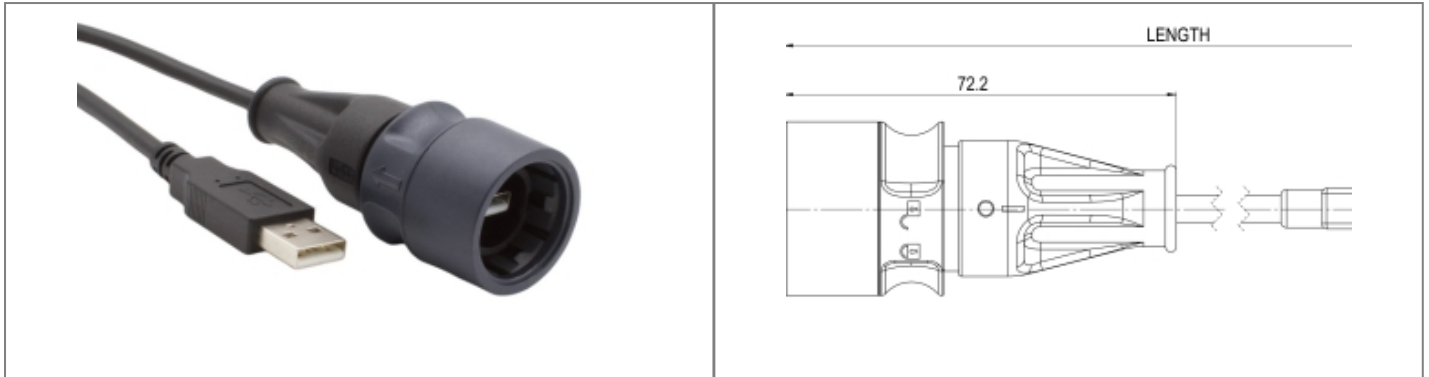







PXP6040/AA/2M00 Datasheet

**Product Name // Plastic Body Overmoulded USB Cable
Standard 2.0 A Plug to Sealed 2.0 A Plug 2M Cable**

 [View Product Page](#)



// Product Description:

-  Pre-Wired Plastic Body Overmoulded USB 2.0 Cable
-  Water and dustproof to IP68 & IP69K when mated with compatible connector
-  30 degree push twist locking, tamperproof lock prevents accidental un-mating
-  Choice of USB A, B & C connections
-  Choice of cable lengths
-  PXP6081 Sealing Cap available separately to maintain IP rating of unmated connectors
-  Mate with 6000 Series Plastic Body USB Panel Mount Connectors

// General Information:

Product Display Title:	Plastic Body Overmoulded USB Cable Standard 2.0 A Plug to Sealed 2.0 A Plug 2M Cable
Product Family:	Circular Data Connectors
Product Series:	6000 Series - USB Buccaneer
Approvals:	CSA, UL, VDE
Body Material:	Polycarbonate/Polybutylene Terephthalate (PC/PBT)
Body Material Type:	Plastic Body
Cable Length:	2m
Contact Type:	Plug Contact
Coupling Type:	Push-Twist
Current Max:	1A
Data Cable Type:	Standard 2.0 A Plug to Sealed 2.0 A Plug
Diameter Over Coupling Ring Mm:	32mm
Flamability Rating:	UL94V-0
Function:	Flex to Standard Connector Double Ended Cable
Ip Rating:	IP66, IP68, IP69K
Max Operating Temperature:	+70°C
Min Operating Temperature:	0°C
Number Of Contacts:	4 Contacts
Voltage Max:	30V

// Product PDF Links

 [6000 Series HDMI Product Data](#)

// Product 3D CAD Model Links

 [PXP6040/AA/2M003D CAD Model](#)



Have a question or project enquiry
you'd like to talk to us about?



[Click Here To Contact Us](#)