

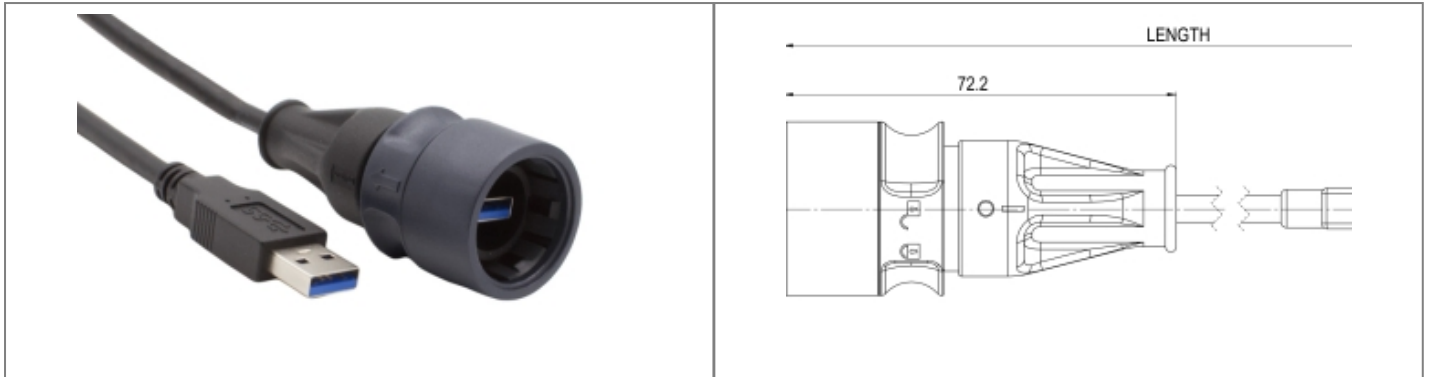







PXP6040/AA3/3M00 Datasheet

**Product Name // Plastic Body Overmoulded USB Cable
Standard 3.0 A Plug to Sealed 3.0 A Plug 3M Cable**

 [View Product Page](#)



// Product Description:

-  Pre-Wired Plastic Body Overmoulded USB 3.0 Cable
-  Water and dustproof to IP68 & IP69K when mated with compatible connector
-  30 degree push twist locking, tamperproof lock prevents accidental un-mating
-  Choice of USB A, B & C connections
-  Choice of cable lengths
-  PXP6081 Sealing Cap available separately to maintain IP rating of unmated connectors
-  Mate with 6000 Series Plastic Body USB Panel Mount Connectors

// General Information:

<p>Product Display Title:</p> <p>Product Family:</p> <p>Product Series:</p> <p>Approvals:</p> <p>Body Material:</p> <p>Body Material Type:</p> <p>Cable Length:</p> <p>Contact Type:</p> <p>Coupling Type:</p> <p>Current Max:</p> <p>Data Cable Type:</p> <p>Diameter Over Coupling Ring Mm:</p> <p>Flamability Rating:</p> <p>Function:</p> <p>Ip Rating:</p> <p>Max Operating Temperature:</p> <p>Min Operating Temperature:</p> <p>Number Of Contacts:</p> <p>Voltage Max:</p>	<p>Plastic Body Overmoulded USB Cable Standard 3.0 A Plug to Sealed 3.0 A Plug 3M Cable</p> <p>Circular Data Connectors</p> <p>6000 Series - USB Buccaneer</p> <p>CSA, UL, VDE</p> <p>Polycarbonate/Polybutylene Terephthalate (PC/PBT)</p> <p>Plastic Body</p> <p>3m</p> <p>Plug Contact</p> <p>Push-Twist</p> <p>1A</p> <p>Standard 3.0 A Plug to Sealed 3.0 A Plug</p> <p>32mm</p> <p>UL94V-0</p> <p>Flex to Standard Connector Double Ended Cable</p> <p>IP66, IP68, IP69K</p> <p>+70°C</p> <p>0°C</p> <p>8 Contacts</p> <p>30V</p>
---	---

// Product PDF Links

 [6000 Series HDMI Product Data](#)

// Product 3D CAD Model Links

 [PXP6040/AA3/3M003D CAD Model](#)