

PXP9010/11/P/1 Datasheet

Product Name // PXP9010/11/P/1

[View Product Page](#)

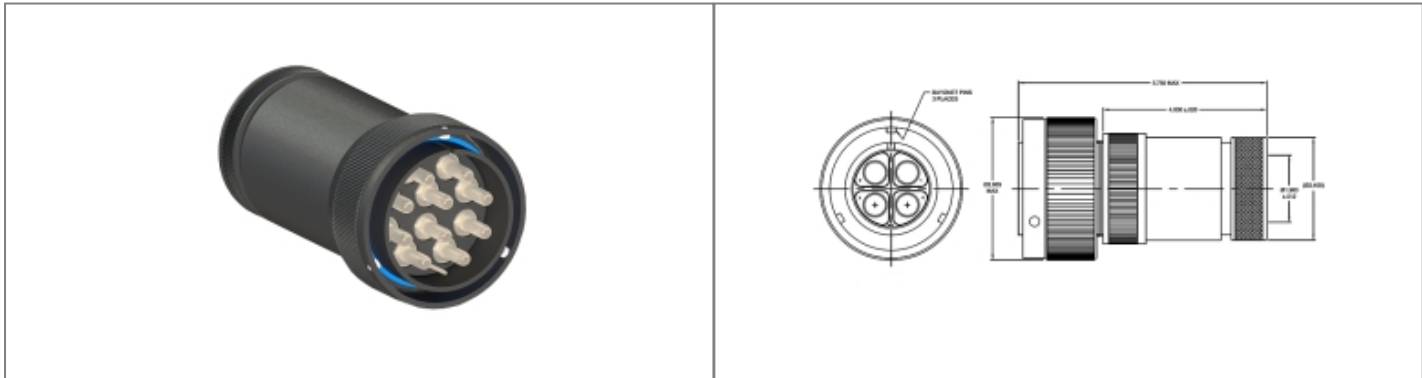

// Product Description:

- ⬡ Male and Female Connectors
- ⬡ Water and dustproof to IP68 when mated with compatible connector
- ⬡ 2, 4, 6, 8, 11 Contact options
- ⬡ Bayonet Quarter Turn Lock
- ⬡ High Amperage 80A, 13A, High Voltage 700VAC

// General Information:

Product Display Title:	9000 Series Buccaneer Connectors
Product Family:	Circular Power Connectors
Product Series:	9000 Series High Power Buccaneer
Body Material:	Delrin
Body Material Type:	Plastic Body
Contact Type:	Plug Contact
Current Max:	80A
Diameter Over Coupling Ring Mm:	72mm
Function:	Flex Cable Connector
Ip Rating:	IP68
Max Operating Temperature:	+125°C
Min Operating Temperature:	-55°C
Number Of Contacts:	11 Contacts
Voltage Max:	700V

// Product PDF Links

[9000 Series Buccaneer Datasheet](#)

// Product 3D CAD Model Links

[PXP9010/11/P/13D CAD Model](#)