

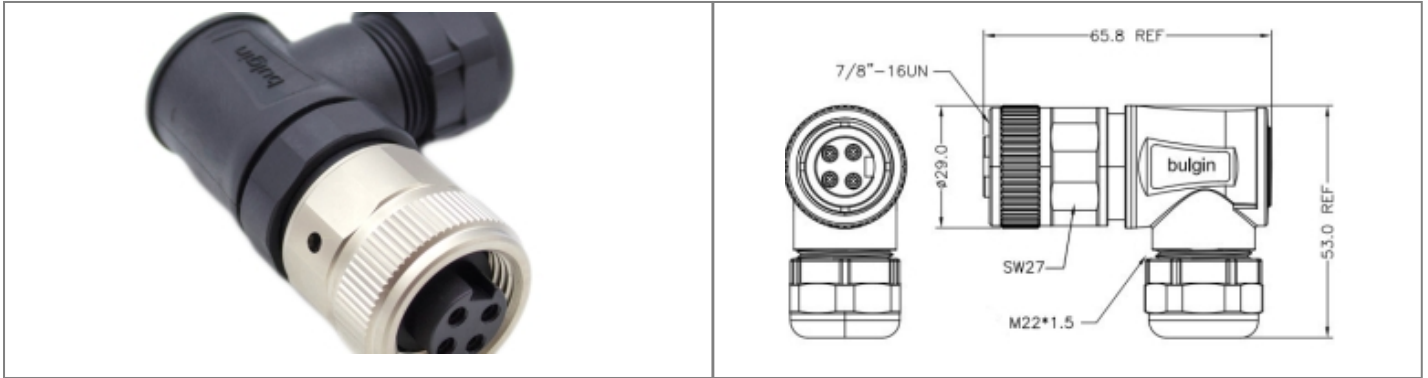





**Product Name // 4 Contacts 7/8" Right Angled Female Connector**
 [View Product Page](#)

**// Product Description:**

-  4 Contacts 7-8" Right Angled Female Connector
-  IP67 rated when mated
-  Mechanical Cycles >100
-  Operating Temperature -25°C to +85°C
-  Rated Voltage 300 V
-  ROHS compliance

**// General Information:**

Product Display Title:	7/8" Right Angled Female Connector
Product Family:	Circular Automation Connectors
Product Series:	7/8" Series
Connection Method:	Screw
Contact Pin Material:	Phosphor bronze gold plated 1u"
Min Coupling Torque:	0.4Nm
Max Coupling Torque:	0.8Nm
Contact Type:	Socket Contact
Current Max:	9A
Durability:	>100 Cycles
Function:	Right Angled Female Connector
Insulation Resistance:	>100MOhm
Ip Rating:	IP67
Max Cable Entry Size:	12mm
Min Cable Entry Size:	6mm
Max Operating Temperature:	+85°C
Min Operating Temperature:	-25°C
Nominal Cross Sectional Area Mm2:	1.5mm2
Number Of Contacts:	4 Contacts
Pin Layout Code:	A Code
Rohs Compliant:	Yes
Thread Size:	M22
Voltage Max:	300V

**// Product PDF Links**
 [78 Series Circular connectors...](#)
**// Product 3D CAD Model Links**
 [PXPTPU78RAF04ASTM223D CAD Model](#)

 Have a question or project enquiry  
 you'd like to talk to us about?

[Click Here To Contact Us](#)