

Product Name // 5 Contacts 7/8" Right Angled Female 1m Cable

[View Product Page](#)

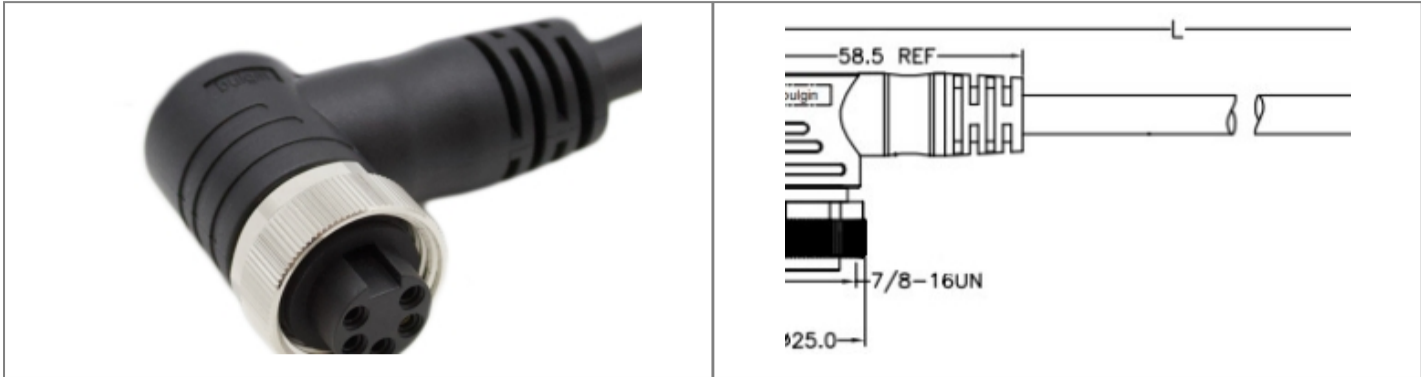

// Product Description:

- ⊗ 5 Contacts 7-8" Right Angled Female 1m Cable
- ⊗ IP67 rated when mated
- ⊗ Mechanical Cycles >100
- ⊗ Operating Temperature= -25°C to +85°C
- ⊗ Rated Voltage 300 V
- ⊗ ROHS compliance

// General Information:

Product Display Title:	7/8" Right Angled Female 1m Cable
Product Family:	Circular Automation Connectors
Product Series:	7/8" Series
Cable Length:	1m
Connection Method:	Solder
Contact Type:	Socket Contact
Current Max:	9A
Durability:	>100 Cycles
Function:	Right Angled Female Connector Single Ended Cable
Insulation Resistance:	>100MOhm
Ip Rating:	IP67
Max Cable Entry Size:	8.5mm
Max Operating Temperature:	+80°C
Min Operating Temperature:	-25°C
Number Of Contacts:	5 Contacts
Pin Layout Code:	A Code
Rohs Compliant:	Yes
Thread Size:	7/8-16UN
Voltage Max:	300V

// Product PDF Links

[78 Series Circular connectors...](#)

// Product 3D CAD Model Links

[PXPTPU78RAF05ACL010PUR3D CAD Model](#)