

PXPTPU78RAM04ACL020PUR Datasheet

Product Name // 4 Contacts 7/8" Right Angled Male 2m Cable

[View Product Page](#)

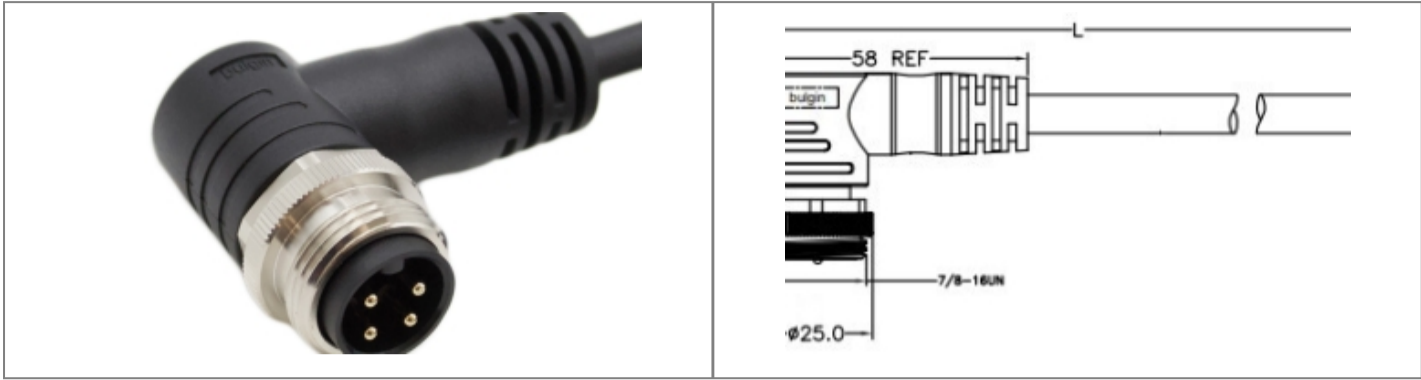

// Product Description:

- ⊕ 3 Contacts 7-8" Right Angled Male 2m Cable
- ⊕ IP67 rated when mated
- ⊕ Mechanical Cycles >100
- ⊕ Operating Temperature -25°C to +85°C
- ⊕ Rated Voltage 300 V
- ⊕ ROHS compliance

// General Information:

Product Display Title:	7/8" Right Angled Male 2m Cable
Product Family:	Circular Automation Connectors
Product Series:	7/8" Series
Cable Length:	2m
Connection Method:	Solder
Contact Type:	Plug Contact
Current Max:	8A
Durability:	>100 Cycles
Function:	Right Angled Male Connector Single Ended Cable
Insulation Resistance:	>100MOhm
Ip Rating:	IP67
Max Cable Entry Size:	7.0mm
Max Operating Temperature:	+80°C
Min Operating Temperature:	-25°C
Number Of Contacts:	4 Contacts
Pin Layout Code:	A Code
Rohs Compliant:	Yes
Thread Size:	7/8-16UN
Voltage Max:	300V

// Product PDF Links

[78 Series Circular connectors...](#)

// Product 3D CAD Model Links

[PXPTPU78RAM04ACL020PUR3D CAD Mod...](#)