

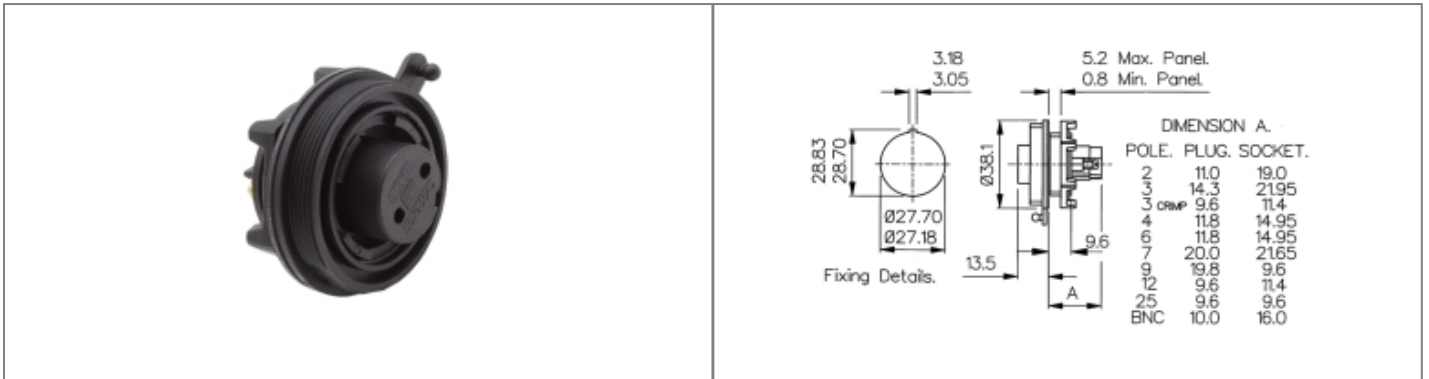









Product Name // Vitalis Buccaneer Front Panel Mount Range (12 Contact)
 [View Product Page](#)

// Product Description:

-  PXV0796/S provides a PCF reduction of 4.1 kg CO₂e per 100 units compared to the equivalent Standard Series Buccaneer part number
-  Front Panel Mount Connector
-  Water and dustproof to IP68 when mated with compatible connectors
-  Single hole fixing
-  Socket contacts
-  12 pole
-  Crimp/Solder contacts, available separately
-  PXV0733 Sealing Cap available separately to maintain IP rating of unmated connectors
-  Mates with Standard Vitalis Series (PXV) and Standard Series (PX) Buccaneer Flex Connectors

// General Information:

Product Display Title:	Vitalis Buccaneer Front Panel Mount Range (12 Contact)
Product Family:	Circular Power Connector
Product Series:	Standard Vitalis Buccaneer
Approvals:	UL, VDE
Body Colour:	Black
Body Material:	Polyamide (PA)- Glass Filled
Body Material Type:	Plastic Body
Contact Type:	Socket Contact
Coupling Type:	Screw
Current Max:	5A
Diameter Over Coupling Ring Mm:	38.1mm
Flamability Rating:	UL94HB
Function:	Front Panel Mount Connector
Insert Colour:	Black Insert
Ip Rating:	IP68, IP69K
Max Contact Accomodation Awg:	22AWG
Min Contact Accomodation Awg:	24AWG
Max Contact Accomodation Mm2:	0.34mm ²
Min Contact Accomodation Mm2:	0.25mm ²
Max Operating Temperature:	+70°C
Min Operating Temperature:	-20°C
Number Of Contacts:	12 Contacts
Rohs Compliant:	Yes
Voltage Max:	50V

// Product PDF Links
 [Standard Vitalis Buccaneer Product...](#)
// Product 3D CAD Model Links
 [PXV0796/S3D CAD Model](#)