



- ⊕ IP68 rating tested at 1.054kg/sq cm (15lb/sq in) 10m depth for 2 weeks and 9.84kg/sq cm (140lb/sq in) 100m depth for 12 hours
- ⊕ IP69K, Tested in accordance with DIN 40050/Part 9 IP6k9K
- ⊕ Water and dustproof to IP68 when mated
- ⊕ 2, 3, 4, 6, 7, 9, 12 and 25 Contact
- ⊕ 12A, 277V AC/DC 2 Contact screw terminal, 3 Contact screw terminal and crimp contacts
- ⊕ 10A, 277V AC/DC 4 Contact screw terminal
- ⊕ 5A, 277V AC/DC 6 and 7 Contact screw terminal
- ⊕ 5A, 150V AC/DC 9 Contact crimp contacts
- ⊕ 5A, 50V AC/DC 12 Contact crimp and solder contacts
- ⊕ 1A, 50V AC/DC 25 Contact crimp and solder contacts
- ⊕ Plug or socket connection in each body style
- ⊕ Compact design
- ⊕ Diameter over coupling ring 38mm
- ⊕ Sealing caps available to maintain IP68 rating of unmated connectors
- ⊕ 7 body styles - flex cable, inline cable, panel mount (front), panel mount (rear), PCB mount, bulkhead and flange mount
- ⊕ Leading earth contact for 3 Contact socket version
- ⊕ Positive locating keyways - cannot be mis-connected
- ⊕ Easy assembly - no special tools required on screw terminal versions
- ⊕ Cable range from 3.5mm - 9mm
- ⊕ Colour coded identification variants
- ⊕ Pre-wired, overmoulded cable assemblies
- ⊕ VDE and cULus approvals
- ⊕ EN60068-2-52 Test Kb Salt Mist (Cyclic) Marine Severity Level 1

Flex Cable Connector



PX0731/P

- Mates with Inline or Panel Mounting Versions
- Screw Locking Ring
- Plug or Socket Versions
- Leading Earth on 3 Contact connectors
- Contacts 2, 3, 4, 6, 7, 9, 12, 25
- Standard Cable Acceptance (2 to 9 Contact) 6-8mm, 3.5-9mm with alternative glands - See page 25

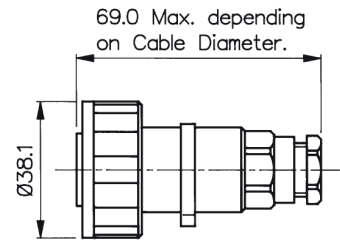

Contacts	Termination	Plug Contacts	Socket Contact	Contacts
2	Screw	PX0736/P	PX0736/S	Supplied Fitted
3	Screw	PX0731/P	PX0731/S	Supplied Fitted
3	Crimp	PX0776/P	PX0776/S	Supplied Loose
4	Screw	PX0748/P	PX0748/S	Supplied Fitted
6	Screw	PX0739/P	PX0739/S	Supplied Fitted
7	Screw	PX0745/P	PX0745/S	Supplied Fitted
9	Crimp	PX0728/P	PX0728/S	Supplied Loose
12	Crimp/Solder	PX0794/P	PX0794/S	Order Separately (SA3348/SA3347)
25	Crimp/Solder	PX0820/P	PX0820/S	Order Separately (SA3180/SA3179)

Inline Cable Connector



PX0732/S

- Mates with Flex or Panel Mounting Versions
- Screw Locking Ring
- Plug or Socket Versions
- Leading Earth on 3 Contact connectors
- Contacts 2, 3, 4, 6, 7, 9, 12, 25
- Standard Cable Acceptance (2 to 9 Contact) 6-8mm, 3.5-9mm with alternative glands - See page 25

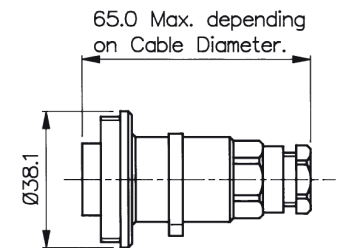

Contacts	Termination	Plug Contacts	Socket Contact	Contacts
2	Screw	PX0737/P	PX0737/S	Supplied Fitted
3	Screw	PX0732/P	PX0732/S	Supplied Fitted
3	Crimp	PX0778/P	PX0778/S	Supplied Loose
4	Screw	PX0749/P	PX0749/S	Supplied Fitted
6	Screw	PX0740/P	PX0740/S	Supplied Fitted
7	Screw	PX0746/P	PX0746/S	Supplied Fitted
9	Crimp	PX0729/P	PX0729/S	Supplied Loose
12	Crimp/Solder	PX0795/P	PX0795/S	Order Separately (SA3348/SA3347)
25	Crimp/Solder	PX0821/P	PX0821/S	Order Separately (SA3180/SA3179)

Pre Wired Flex Cable Connector



PX0700

- Overmoulded cable assemblies
- Up to 14mm dia cable with PVC or PU jackets
- Mates with Inline connector and all panel connectors

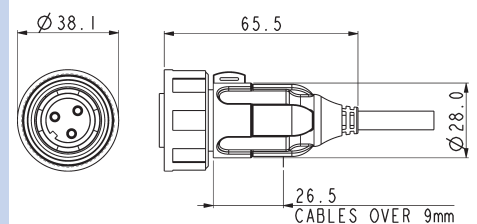

Front Panel Mounting Connector



PX0730/P

- Mates with Flex Cable Connector
- Single Hole Fixing
- Plug or Socket Versions
- Contacts 2, 3, 4, 6, 7, 9, 12, 25

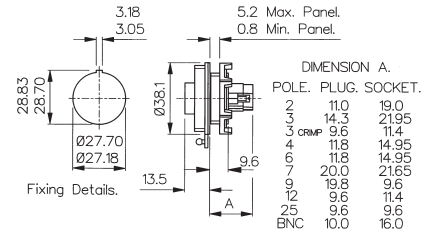

Contacts	Termination	Plug Contacts	Socket Contact	Contacts
2	Screw	PX0735/P	PX0735/S	Supplied Fitted
3	Screw	PX0730/P	PX0730/S	Supplied Fitted
3	Crimp	PX0779/P	PX0779/S	Supplied Loose
4	Screw	PX0747/P	PX0747/S	Supplied Fitted
6	Screw	PX0738/P	PX0738/S	Supplied Fitted
7	Screw	PX0744/P	PX0744/S	Supplied Fitted
9	Crimp	PX0727/P	PX0727/S	Supplied Loose
12	Crimp/Solder	PX0796/P	PX0796/S	Order Separately
25	Crimp/Solder	PX0822/P	PX0822/S	Order Separately

Rear Panel Mounting Connector



PX0709/P/03

- Mates with Flex Cable Connector
- Single Hole Fixing
- Plug or Socket Versions
- Contacts 2, 3, 4, 6, 7, 9, 12 or 25

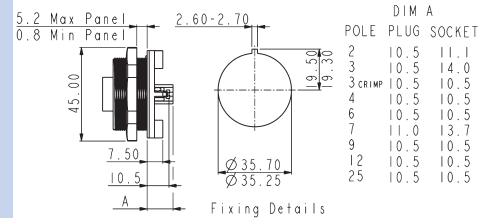

Contacts	Termination	Plug Contacts	Socket Contact	Contacts
2	Screw	PX0709/P/02	PX0709/S/02	Supplied Fitted
3	Screw	PX0709/P/03	PX0709/S/03	Supplied Fitted
3	Crimp	PX0708/P/03	PX0708/S/03	Supplied Loose
4	Screw	PX0709/P/04	PX0709/S/04	Supplied Fitted
6	Screw	PX0709/P/06	PX0709/S/06	Supplied Fitted
7	Screw	PX0709/P/07	PX0709/S/07	Supplied Fitted
9	Crimp	PX0708/P/09	PX0708/S/09	Supplied Loose
12	Crimp/Solder	PX0708/P/12	PX0708/S/12	Order Separately (SA3348/SA3347)
25	Crimp/Solder	PX0708/P/25	PX0708/S/25	Order Separately (SA3180/SA3179)

Sprung Loaded Sealing Cap



PX0713

- IP54 rated
- Spring loaded
- Clip shut to seal
- For use with front of panel mounting connector types

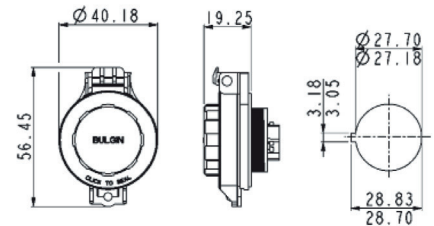

Rear PCB Mounting Connector



PX0707/P/12

- Mates with Flex Cable connector
- No. Contacts: 3, 4, 6, 9, 12 or 25
- Plug or socket versions
- Pre-loaded Gold Plated contacts

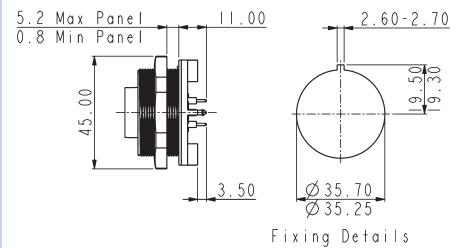

Contacts	Termination	Plug Contacts	Socket Contact	Contacts
3	PCB	PX0707/P/03	PX0707/S/03	Supplied Fitted
4	PCB	PX0707/P/04	PX0707/S/04	Supplied Fitted
6	PCB	PX0707/P/06	PX0707/S/06	Supplied Fitted
9	PCB	PX0707/P/09	PX0707/S/09	Supplied Fitted
12	PCB	PX0707/P/12	PX0707/S/12	Supplied Fitted
25	PCB	PX0707/P/25	PX0707/S/25	Supplied Fitted

Bulkhead Flange Mounting Connector



PX0756/S

- Mates with Flex Cable Connector
- Plug or Socket Versions
- Contacts 2, 3, 4, 6, 7, 9, 12, 25
- Supplied with sealing gasket and screw sealing grommets

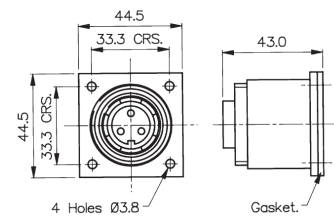

Contacts	Termination	Plug Contacts	Socket Contact	Contacts
2	Screw	PX0757/P	PX0757/S	Supplied Fitted
3	Screw	PX0756/P	PX0756/S	Supplied Fitted
3	Crimp	PX0787/P	PX0787/S	Supplied Loose
4	Screw	PX0761/P	PX0761/S	Supplied Fitted
6	Screw	PX0758/P	PX0758/S	Supplied Fitted
7	Screw	PX0760/P	PX0760/S	Supplied Fitted
9	Crimp	PX0762/P	PX0762/S	Supplied Loose
12	Crimp/Solder	PX0798/P	PX0798/S	Order Separately (SA3348/SA3347)
25	Crimp/Solder	PX0823/P	PX0823/S	Order Separately (SA3180/SA3179)

Low Profile Flange Mounting Connector



PX0765/S

- Screw Flange Fixing
- Plug or Socket Versions
- Contacts 2, 3, 4, 6, 7, 9, 12, 25
- Mates with Flex Cable Connector
- Supplied with sealing gasket and screw sealing grommets

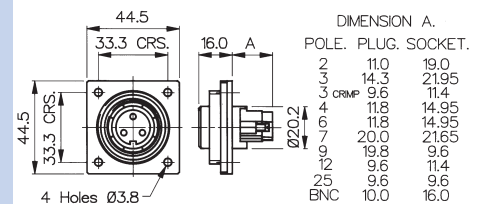

Contacts	Termination	Plug Contacts	Socket Contact	Contacts
2	Screw	PX0764/P	PX0764/S	Supplied Fitted
3	Screw	PX0765/P	PX0765/S	Supplied Fitted
3	Crimp	PX0781/P	PX0781/S	Supplied Loose
4	Screw	PX0766/P	PX0766/S	Supplied Fitted
6	Screw	PX0767/P	PX0767/S	Supplied Fitted
7	Screw	PX0768/P	PX0768/S	Supplied Fitted
9	Crimp	PX0769/P	PX0769/S	Supplied Loose
12	Crimp/Solder	PX0797/P	PX0797/S	Order Separately (SA3348/SA3347)
25	Crimp/Solder	PX0824/P	PX0824/S	Order Separately (SA3180/SA3179)

Coloured Contact Inserts



Coloured Inserts

- With or without matching gland nut
- Positive visual identification
- Available in; Black, Blue, Green, Grey, Light Grey, Red, White and Yellow

Contact Inserts Colour Options

Part No	Suffix Colour
Blank	Black
BL	Blue
GN	Green
GY	Grey
LG	Light Grey
RD	Red
WH	White
YL	Yellow

Insert/Gland Nut Combinations

1	Insert and Gland Nut Coloured
2	Insert Only Coloured

E.g. PX0731/P/YL1 = Yellow insert and gland nut

Contacts for 12 and 25 Contact Inserts



12 and 25 way contacts

- Crimp or Solder Plugs and Sockets
- Gold Plated
- Current ratings:  
12 way: 5A, 50V  
25 way: 1A, 50V

Contacts - Solder & Crimp for 12 and 25 Contact

Contacts (for 12 Contact) (Supplied in packs of 10)	Solder	Crimp
Plugs	SA3348/1	SA3348
Sockets	SA3347/1	SA3347
Contacts (for 25 Contact) (Supplied in packs of 10)	Solder	Crimp
Plugs	SA3180/1	SA3180
Sockets	SA 3179/1	SA3179

Assembly Tools



PNo 14025 and 13027

- Crimp Tools for 3, 9, 12 and 25 Contact crimp contacts
- Insertion/Extraction Tool for 25 Contact contacts

Tools

Crimp Tool (25 Contact)	PNo. 14025/1AMP
Crimp Tool (12 Contact)	PNo. 14025
Positioner (12 Contact)	PNo. 14025/5AMP
Crimp Tool (9 Contact)	PNo. 13826
Crimp Tool (3 Contact)	PNo. 14232
3 Contact positioner	PNo. 14232/1
Insertion/Extraction Tool (25 Contact)	PNo. 13027
Insertion/Extraction Tool (12 Contact)	PNo. 13027/1
Insertion/Extraction Tool (3 Contact)	PNo. 13027/3

Cable Glands



12023/1, 12023/2 & SA3253

- Pack of alternative cable glands to suit cables from 3.5 to 9mm dia.

Cable Acceptance - Alternatives

Gland Diameter	Gland Part No.	Gland Colour	Additional Suffix
6-8mm	12023	Black	Standard for 2-12 Contact
3.5-5mm	SA3426	Grey	Suffix /04†
5-7mm	12023/1	White	Suffix /05
7-9mm	12023/2	Yellow	Suffix /07*
Gland Pack	SA3253	Pack of 3 glands to suit cables 3.5-5mm, 5-7mm & 7-9mm dia†	

\*Note: 7-9mm gland standard for 25 way, no suffix required.  
†Includes additional black gland cage for 3.5-5mm dia. cable range.

To order connector with alternative cable gland add suffix to part no. e.g. PX0731/P/07 = PX0731 3 Plug connector with cable gland to suit 7-9mm dia. cable.

Cable Acceptance - Standard as supplied

No. Contacts	Cable Diameter or Type
2-12 Contact	6-8mm
25 Contact	7-9mm

Sealing Cap and Assembling Tool



PX0734 & PX0733

- Maintains IP68 Rating of Unmated Connectors
- Can be used to remove Inserts
- PX0734 for Flex Cable Connector
- PX0733 for Inline, Front Panel, Bulkhead and Flange mount connectors
- PX0711 for PCB and Rear Panel Mount connectors

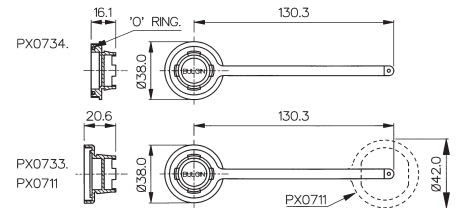

Rear of Panel Back Shell



PX0799

- Provides environmental seal to rear of panel
- Standard cable acceptance 6-8mm, 3.5 to 9mm with alternative glands
- For use on front panel mounting connectors
- Replaces mounting nut in panel connector

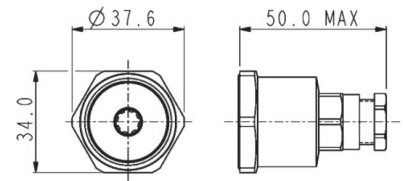

PVC Insulation Boot



PNo. 12855

- Shock protection for rear of connector
- Flammability Rating UL94V-0
- Fits Front Panel Mount Versions only

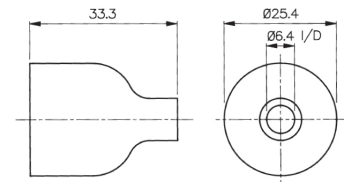

Cable Support Accessory



PNo. 12237

- Gives Extra Support to the Cable
- Suitable for 5-7mm and 7-9mm Cable Diameters

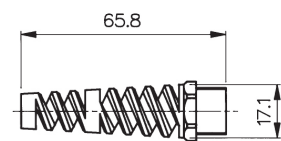

PX07XX	X	XX	XX	X
<b>Body Styles</b>	<b>Contacts Type</b>	<b>Cable Acceptance or PCB/Rear Panel Mounting</b>	<b>Insert/Gland Nut Colour</b>	<b>Insert/Gland Nut Colour Combination</b>
PX0736 PX0731 PX0776 PX0748 PX0739 PX0745 PX0728 PX0794 PX0820 PX0737 PX0732 PX0778 PX0749 PX0740 PX0746 PX0729 PX0795 PX0821 PX0735 PX0730 PX0779 PX0747 PX0738 PX0744 PX0727 PX0796 PX0822 PX0709 PX0708 PX0707 PX0757 PX0756 PX0787 PX0761 PX0758 PX0760 PX0762 PX0798 PX0823 PX0764 PX0765 PX0781 PX0766 PX0767 PX0768 PX0769 PX0797 PX0824	P = Plug S = Socket	Flex Cable and Inline Connectors cable acceptance use: Blank = 6-8mm (Black) standard for 2-12 Contact  04 = 3.5-5mm (Grey) 05 = 5-7mm (White) 07 = 7-9mm (Yellow) (standard for 25 way, no suffix required)  PCB (PX0707) and Rear Panel Mount connectors (PX0708 and PX0709) use:  02 = 2 Contact      03 = 3 Contact 04 = 4 Contact      06 = 6 Contact 07 = 7 Contact      09 = 9 Contact 12 = 12 Contact     25 = 25 Contact  Front Panel, Bulkhead and Flange Mount - not required:	Blank = Black BL = Blue GN = Green GY = Grey  LG = Light Grey RD = Red WH = White YL = Yellow	1 = Insert and Gland Nut Coloured 2 = Insert only Coloured
<b>Examples:</b>				
PX0707/P/06= PCB Panel connector, Plug contacts, 6 Contact PX0731/S = Flex Cable connector, socket contacts, 3 Contact PX0732/P/07/BL2 = Inline Cable connector, Plug contacts, 3 Contact, 7-9mm cable acceptance, blue insert				

**PCB Layouts**

**Sockets**

Contact Nos viewed from rear of panel

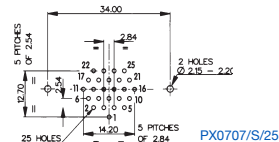
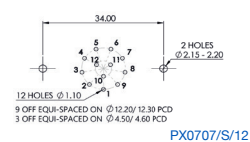
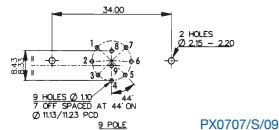
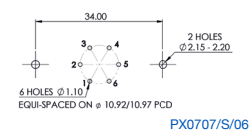
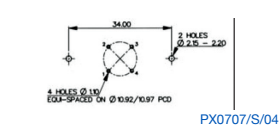
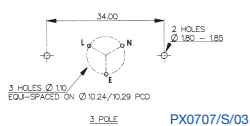

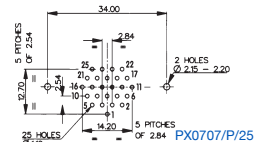
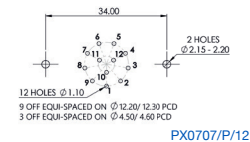
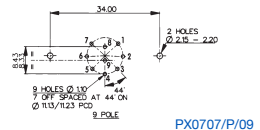
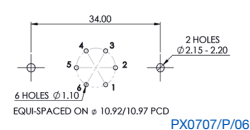
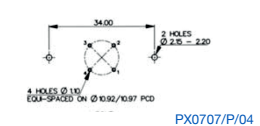
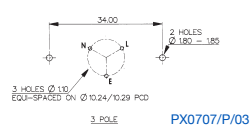

**Plugs**

Contact Nos viewed from rear panel rear of panel



**Electrical:**

No. Contacts:	2, 3	4	6, 7	9	12	25
Current Rating:						
VDE	12A	10A	5A	5A	5A	1A
UL	12A	10A	5A	5A	5A	1A
Voltage Rating (AC/DC):	277V	277V	277V	150V	50V	50V
Contact Resistance:	<10mΩ (2-9 Contact)					
	<5mΩ (12 Contact)					
	<5mΩ (25 Contact)					
Insulation Resistance:	>10 <sup>4</sup> MΩ @ 500V DC (2-9 Contact)					
AC Breakdown voltage:	4kV Contact - Contact (2-9 Contact)					
	6kV Contacts - Panel (Low Profile Flange and Panel Types – 2-9 Contact)					
	7.5kV Contacts - Panel (Other Types – 2-9 Contact)					
Operating Temp. Range:	-20°C to +70°C					
Approvals:						
 UL (Underwriters Laboratory)	E93288 and E337507					
 VDE (Verband der Elektrotechnik)	40023148					
	Overmoulded cable assemblies approvals to customer requirements.					

**Material:**

Body Mouldings:	Glass Filled Polyamide UL94HB
Inserts (2-25 Contact):	Polyamide UL94V-0
PX0707	Polyamide UL94V-0
PX0708	Polyamide UL94V-0
PX0709	Polyamide UL94V-0
Overmoulded types:	
Body Mouldings:	Polyurethane
Flammability Rating:	UL94V-HB
Contacts:	
Screw Terminal:	Brass, Nickel Plated
Crimp (9 Contact):	Copper Alloy, Tin Plated
Crimp/Solder (12+25 Contact):	Copper Alloy, Gold Plated (0.1µm on Nickel)
BNC inserts:	Brass, Nickel Plated
BNC contacts:	Brass, Silver Plated
RoHS	Compliant

**Mechanical:**

Sealing:	IP69K, Tested in accordance with DIN 40050/Part 9 IP6k9k
	IP68, EN 60529:1992+A2:2013 Tested @ 1.054kg/sq.cm. (15lb/sq.in.) 10m depth for 2 weeks.
	EN 60529:1992 +A2:2013 Tested @ 9.84kg/sq.cm. (140lb/sq.in.) 100m depth for 12 hours.
Salt Mist:	EN60068-2-52 Test Kb Salt Mist (Cyclic) Marine Severity Level 1
Cable Acceptance:	
2-12 Contact - standard gland:	6-8mm dia
2-12 Contact - alternative glands:	3.5-9mm dia
25 Contact - standard gland:	7-9mm dim
25 Contact - alternative glands:	3.5-7mm dim
Contact Accommodation:	
2 and 3 Contact screw terminals:	2.5-4mm <sup>2</sup> (12-14AWG)
3 Contact crimp:	1-1.5mm <sup>2</sup> (16-17AWG)
4, 6 and 7 Contact:	1-1.5mm <sup>2</sup> (17-16AWG)
9 Contact:	0.14-0.25mm <sup>2</sup> (24-26AWG)
12 Contact:	0.25-0.34mm <sup>2</sup> (22-24AWG)
25 Contact:	0.14-0.25mm <sup>2</sup> (24-26AWG)
Terminations:	
2-7 Contact:	Screw Terminals
3 Contact:	Screw Terminals & Crimp
9 Contact:	Crimp Contacts
12 Contact:	Crimp & Solder Contacts
25 Contact:	Crimp & Solder Contacts
Tightening Torques:	
Flex Mounting/Inline:	Gland Nut: 1.13Nm (10lbf.in.)
Panel Mounting:	Rear Fixing Nut: 1.7Nm (15lbf.in.)
	Front Fixing Nut: 1.4Nm (12.4lbf.in.)
Surface/Bulkhead and Low Profile Flange Mounting:	4 Fixing Screws (using washers supplied) 0.34Nm (3lbf.in.)
Sealings Caps/Locking Ring:	1.13Nm (10lbf.in.)
Rear thread, Front Panel Connector:	M27 x 1.0-6H
Thread, Front Panel Connector:	M35 x 1.0-6H





Cable Joiner

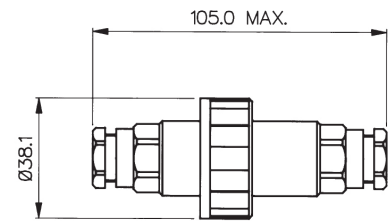

PX0777

- IP68 & IP69k Rating
- For Sealed Inline Connections
- Standard Cable Acceptance 6-8mm
- Cable Range 3.5-9mm (using alternative glands)
- Supplied with 4, 6 or 8 way Terminal Block
- Available Moulded in Black or Orange

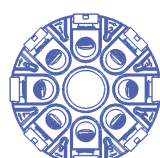

Specifications	PX0777	PX0777/4POLE, 6POLE, 8POLE	POLE Configurations
Rating:	16A, 250V AC	10A, 250V AC	
Wire Termination:	3 way Terminal Block	4, 6, 8 way Terminal Block	
Conductor Accommodation:	2.5mm <sup>2</sup> max (14AWG)	1.5mm <sup>2</sup> max (16AWG)	
Cable Acceptance:	6-8mm dia alternative glands available on request	6-8mm dia alternative glands available on request	
Material:	Glass Filled Polyamide UL94-HB	Glass Filled Polyamide UL94-V0	
Sealing:	IP68 to BSEN 60529 : 1992 1.054kg/sq.cm. (15lbs/sq.in.) 10m depth for 2 weeks	IP68 to BSEN 60529 : 1992 1.054kg/sq.cm. (15lbs/sq.in.) 10m depth for 2 weeks	
Salt Mist	EN60068-2-52 Test Kb Salt Mist (Cyclic) Marine Severity Level 1	EN60068-2-52 Test Kb Salt Mist (Cyclic) Marine Severity Level 1	
Operating Temp. Range:	-20°C to +70°C	-20°C to +70°C	
Colour:	Black Orange (Add /OR to PNo.)	Black Orange (Add /OR to PNo.)	
RoHS	Compliant	Compliant	

**Examples**

- PX0777 – 3 Contact 6-8mm Black.
- PX0777/04 – 3 Contact 3.5-5.0mm Black.
- PX0777/04/OR – 3 Contact 3.5-5.0mm Orange.
- PX0777/4POLE – 4 Contact 6-8mm Black.
- PX0777/6POLE/04 – 6 Contact 3.5-5.0mm Black.
- PX0777/8POLE/04/OR – 8 Contact 3.5-5.0mm Orange.

<b>PX0777</b>	<b>XPOLE</b>	<b>XX</b>	<b>XX</b>
Part No	Blank = 3 Contact 4POLE = 4 Contact 6POLE = 6 Contact 8POLE = 8 Contact	Blank = 6-8mm 04 = 3.5-5mm 05 = 5-7mm 07 = 7-9mm	Blank = Black OR = Orange

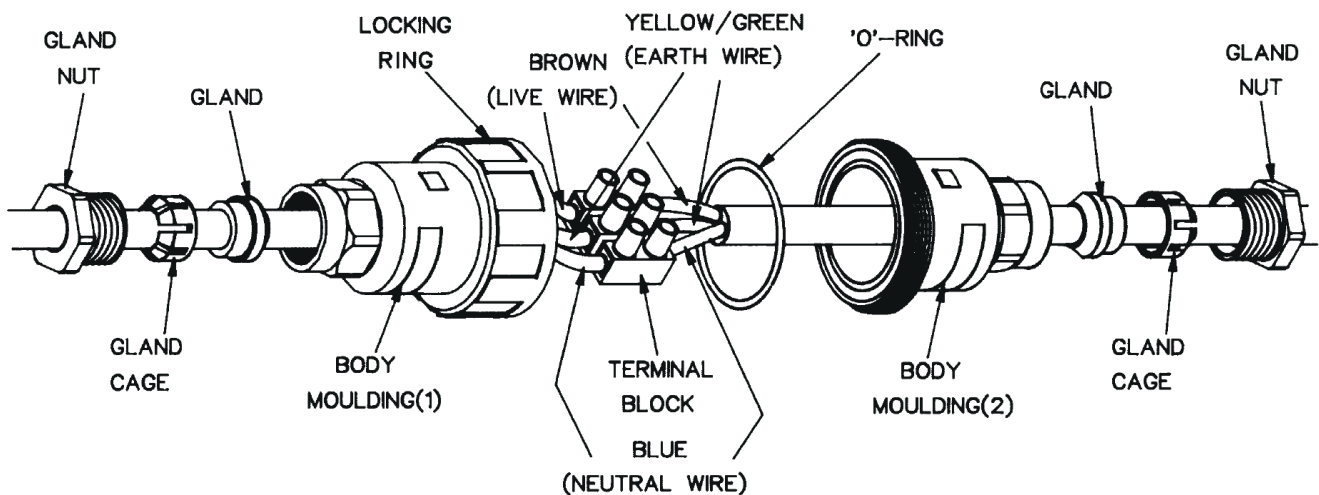

1. Strip wires to dimensions shown.
2. Assemble components parts onto cable as shown, then connect wires to terminal block.

ENSURING WIRES CONNECTED INTO ONE SIDE OF TERMINAL BLOCK MATCH WIRES CONNECTED INTO THE OTHER SIDE.

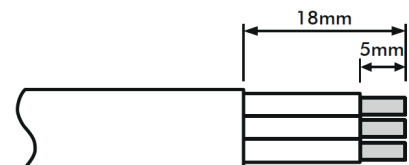

Wire stripping details

- i.e. Brown to Brown (Live)  
Blue to Blue (Neutral)  
Green/Yellow to Green/Yellow (Earth)

3. Bring the two body mouldings together ensuring the 'O' ring is correctly located in groove then lock together with locking ring, ensure ring is fully tightened.

Put gland cage over gland and push fully home into its appropriate body then fully tighten gland nuts.

4. To ensure a good seal, all surfaces must be completely free of dust, grease or any other contamination.

THIS CABLE CONNECTOR IS SUITABLE FOR USE WITH LOADS NOT EXCEEDING 16 AMPS USING 1.5mm<sup>2</sup> CABLE

ALWAYS USE WITH SUPPLY PROTECTED BY AN RCD (RESIDUAL CURRENT DEVICE), IF IN DOUBT CONSULT A QUALIFIED ELECTRICIAN.

**DANGER**  
DISCONNECT MAINS SUPPLY BEFORE DISMANTLING CONNECTOR

The **vitalis Buccaneer series** is engineered for a world where performance meets responsible material use. Its outer casing contains up to **86% bio-based plastics**, offering a more sustainable choice without compromising strength, reliability, or durability in harsh environments.



**vitalis**

- Standard **vitalis** Buccaneer products contain up to 86% bio-based content by weight (mass-balanced approach)
- Bio-based plastics enable Product Carbon Footprint (PCF) reductions
- IP68 rating tested at 1.054kg/sq cm (15lb/sq in) 10m depth for 2 weeks and 9.84kg/sq cm (140lb/sq in) 100m depth for 12 hours (when mated)
- EN 60068-2-52 Test Kb Salt Mist (Cyclic) Marine Severity Level 1
- 2, 3, 4, 6, 7, 9, 12 and 25 Contact
- 12A, 277V AC/DC 2 Contact screw terminal, 3 Contact screw terminal and crimp contacts
- 10A, 277V AC/DC 4 Contact screw terminal
- 5A, 277V AC/DC 6 and 7 Contact screw terminal
- 5A, 150V AC/DC 9 Contact crimp contacts
- 5A, 50V AC/DC 12 Contact crimp and solder contacts
- 1A, 50V AC/DC 25 Contact crimp and solder contacts
- Plug or socket contact connection in each body style
- Compact design
- Diameter over coupling ring 38mm
- Sealing caps available to maintain IP68 rating of unmated connectors
- 7 body styles - flex cable, inline cable, panel mount (front), panel mount (rear), PCB mount, bulkhead and flange mount
- Leading earth contact for 3 Contact version
- Positive locating keyways - cannot be mis-connected
- Easy assembly - no special tools required on screw terminal versions
- Cable range from 3.5mm - 9mm
- VDE and cULus approvals

Flex Cable Connector



PXV0731/S

- Average PCF reduction of 8.6 kg CO<sub>2</sub>e per 100 units
- Mates with Inline or Panel/Flange Mounting Versions
- Screw Locking Ring
- Plug or Socket Versions
- Contacts 2, 3, 4, 6, 7, 9, 12, 25
- Standard Cable Acceptance (2 to 9 Contact) 6-8mm, 3.5-9mm with alternative glands - See page 28

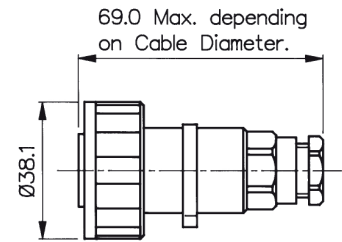

Contacts	Termination	Plug Contacts	Socket Contacts	Contacts
2	Screw	PXV0736/P	PXV0736/S	Supplied Fitted
3	Screw	PXV0731/P	PXV0731/S	Supplied Fitted
3	Crimp	PXV0776/P	PXV0776/S	Supplied Loose
4	Screw	PXV0748/P	PXV0748/S	Supplied Fitted
6	Screw	PXV0739/P	PXV0739/S	Supplied Fitted
7	Screw	PXV0745/P	PXV0745/S	Supplied Fitted
9	Crimp	PXV0728/P	PXV0728/S	Supplied Loose
12	Crimp/Solder	PXV0794/P	PXV0794/S	Order Separately (SA3348/SA3347)
25	Crimp/Solder	PXV0820/P	PXV0820/S	Order Separately (SA3180/SA3179)

Inline Cable Connector



PXV0737/S

- Average PCF reduction of 4.9 kg CO<sub>2</sub>e per 100 units
- Mates with Flex Cable Connector
- Plug or Socket Versions
- Contacts 2, 3, 4, 6, 7, 9, 12, 25
- Standard Cable Acceptance (2 to 9 Contact) 6-8mm, 3.5-9mm with alternative glands - See page 28

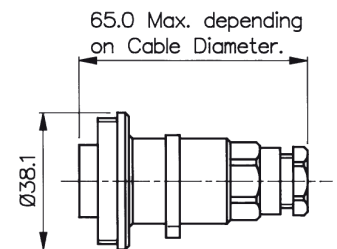

Contacts	Termination	Plug Contacts	Socket Contacts	Contacts
2	Screw	PXV0737/P	PXV0737/S	Supplied Fitted
3	Screw	PXV0732/P	PXV0732/S	Supplied Fitted
3	Crimp	PXV0778/P	PXV0778/S	Supplied Loose
4	Screw	PXV0749/P	PXV0749/S	Supplied Fitted
6	Screw	PXV0740/P	PXV0740/S	Supplied Fitted
7	Screw	PXV0746/P	PXV0746/S	Supplied Fitted
9	Crimp	PXV0729/P	PXV0729/S	Supplied Loose
12	Crimp/Solder	PXV0795/P	PXV0795/S	Order Separately (SA3348/SA3347)
25	Crimp/Solder	PXV0821/P	PXV0821/S	Order Separately (SA3180/SA3179)

Front Panel Mounting Connector



PXV0735/S

- Average PCF reduction of 4.4 kg CO<sub>2</sub>e per 100 units
- Mates with Flex Cable Connector
- Single Hole Fixing
- Plug or Socket Versions
- Contacts 2, 3, 4, 6, 7, 9, 12, 25

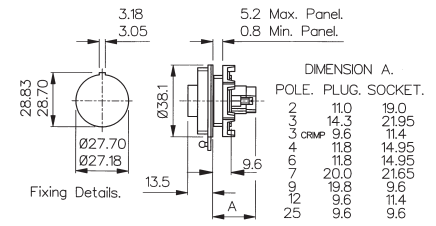

Contacts	Termination	Plug Contacts	Socket Contacts	Contacts
2	Screw	PXV0735/P	PXV0735/S	Supplied Fitted
3	Screw	PXV0730/P	PXV0730/S	Supplied Fitted
3	Crimp	PXV0779/P	PXV0779/S	Supplied Loose
4	Screw	PXV0747/P	PXV0747/S	Supplied Fitted
6	Screw	PXV0738/P	PXV0738/S	Supplied Fitted
7	Screw	PXV0744/P	PXV0744/S	Supplied Fitted
9	Crimp	PXV0727/P	PXV0727/S	Supplied Loose
12	Crimp/Solder	PXV0796/P	PXV0796/S	Order Separately (SA3348/SA3347)
25	Crimp/Solder	PXV0822/P	PXV0822/S	Order Separately (SA3180/SA3179)

Rear Panel Mounting Connector



PXV0709/S/02

- Average PCF reduction of 8.9 kg CO<sub>2</sub>e per 100 units
- Mates with Flex Cable Connector
- Single Hole Fixing
- Plug or Socket Versions
- Contacts 2, 3, 4, 6, 7, 9, 12 or 25

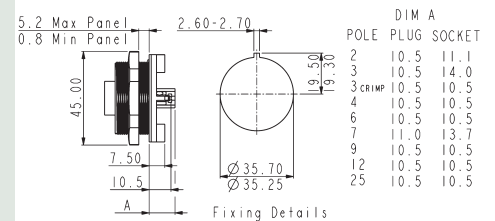

Contacts	Termination	Plug Contacts	Socket Contacts	Contacts
2	Screw	PXV0709/P/02	PXV0709/S/02	Supplied Fitted
3	Screw	PXV0709/P/03	PXV0709/S/03	Supplied Fitted
3	Crimp	PXV0708/P/03	PXV0708/S/03	Supplied Loose
4	Screw	PXV0709/P/04	PXV0709/S/04	Supplied Fitted
6	Screw	PXV0709/P/06	PXV0709/S/06	Supplied Fitted
7	Screw	PXV0709/P/07	PXV0709/S/07	Supplied Fitted
9	Crimp	PXV0708/P/09	PXV0708/S/09	Supplied Loose
12	Crimp/Solder	PXV0708/P/12	PXV0708/S/12	Order Separately (SA3348/SA3347)
25	Crimp/Solder	PXV0708/P/25	PXV0708/S/25	Order Separately (SA3180/SA3179)

Rear PCB Mounting Connector



PXV0707/S/09

- Average PCF reduction of 8.9 kg CO<sub>2</sub>e per 100 units
- Mates with Flex Cable connector
- No. Contacts: 3, 4, 6, 9, 12 or 25
- Plug or socket versions
- Pre-loaded Gold Plated contacts

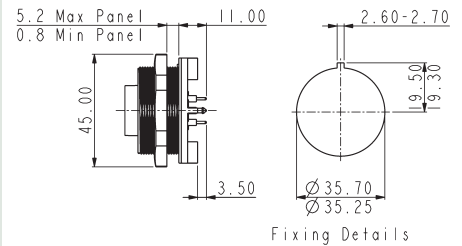

Contacts	Termination	Plug Contacts	Socket Contacts	Contacts
3	PCB	PXV0707/P/03	PXV0707/S/03	Supplied Fitted
4	PCB	PXV0707/P/04	PXV0707/S/04	Supplied Fitted
6	PCB	PXV0707/P/06	PXV0707/S/06	Supplied Fitted
9	PCB	PXV0707/P/09	PXV0707/S/09	Supplied Fitted
12	PCB	PXV0707/P/12	PXV0707/S/12	Supplied Fitted
25	PCB	PXV0707/P/25	PXV0707/S/25	Supplied Fitted

Bulkhead Flange Mounting Connector



PXV0757/S

- Average PCF reduction of 5.9 kg CO<sub>2</sub>e per 100 units
- Mates with Flex Cable Connector
- Plug or Socket Versions
- Contacts 2, 3, 4, 6, 7, 9, 12, 25
- Supplied with sealing gasket and screw sealing grommets

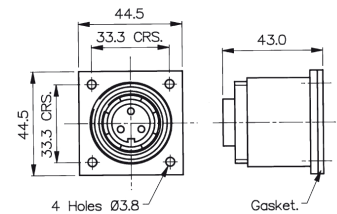

Contacts	Termination	Plug Contacts	Socket Contacts	Contacts
2	Screw	PXV0757/P	PXV0757/S	Supplied Fitted
3	Screw	PXV0756/P	PXV0756/S	Supplied Fitted
3	Crimp	PXV0787/P	PXV0787/S	Supplied Loose
4	Screw	PXV0761/P	PXV0761/S	Supplied Fitted
6	Screw	PXV0758/P	PXV0758/S	Supplied Fitted
7	Screw	PXV0760/P	PXV0760/S	Supplied Fitted
9	Crimp	PXV0762/P	PXV0762/S	Supplied Loose
12	Crimp/Solder	PXV0798/P	PXV0798/S	Order Separately (SA3348/SA3347)
25	Crimp/Solder	PXV0823/P	PXV0823/S	Order Separately (SA3180/SA3179)

Low Profile Flange Mounting Connector



PXV0764/S

- Average PCF reduction of 2.6 kg CO<sub>2</sub>e per 100 units
- Screw Flange Fixing
- Plug or Socket Versions
- Contacts 2, 3, 4, 6, 7, 9, 12, 25
- Mates with Flex Cable Connector
- Supplied with sealing gasket and screw sealing grommets

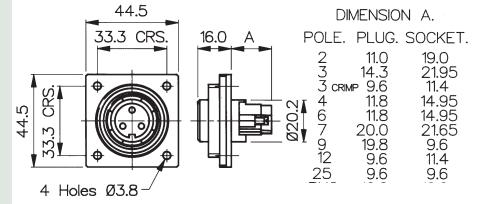

Contacts	Termination	Plug Contacts	Socket Contacts	Contacts
2	Screw	PXV0764/P	PXV0764/S	Supplied Fitted
3	Screw	PXV0765/P	PXV0765/S	Supplied Fitted
3	Crimp	PXV0781/P	PXV0781/S	Supplied Loose
4	Screw	PXV0766/P	PXV0766/S	Supplied Fitted
6	Screw	PXV0767/P	PXV0767/S	Supplied Fitted
7	Screw	PXV0768/P	PXV0768/S	Supplied Fitted
9	Crimp	PXV0769/P	PXV0769/S	Supplied Loose
12	Crimp/Solder	PXV0797/P	PXV0797/S	Order Separately (SA3348/SA3347)
25	Crimp/Solder	PXV0824/P	PXV0824/S	Order Separately (SA3180/SA3179)

Contacts for 12 and 25 Contact Inserts



12 and 25 way contacts

- Crimp or Solder Plugs and Sockets
- Gold Plated
- Current ratings:  
12 way: 5A, 50V  
25 way: 1A, 50V

Contacts - Solder & Crimp for 12 and 25 Contact

Contacts (for 12 Contact) (Supplied in packs of 10)	Solder	Crimp
Plugs	SA3348/1	SA3348
Sockets	SA3347/1	SA3347
Contacts (for 25 Contact) (Supplied in packs of 10)	Solder	Crimp
Plugs	SA3180/1	SA3180
Sockets	SA3179/1	SA3179

Assembly Tools



14025 and 13027

- Crimp Tools for 3, 9, 12 and 25 Contact crimp contacts
- Insertion/Extraction Tool for 3, 12, & 25 Contacts

Tools

Crimp Tool (25 Contact)	PNo. 14025/1AMP
Crimp Tool (12 Contact)	PNo. 14025
Positioner (12 Contact)	PNo. 14025/5AMP
Crimp Tool (9 Contact)	PNo. 13826
Crimp Tool (3 Contact)	PNo. 14232
3 Contact positioner	PNo. 14232/1
Insertion/Extraction Tool (25 Contact)	PNo. 13027
Insertion/Extraction Tool (12 Contact)	PNo. 13027/1
Insertion/Extraction Tool (3 Contact)	PNo. 13027/3

Cable Glands



12023/1, 12023/2 & SA3253

- Pack of alternative cable glands to suit cables from 3.5 to 9mm dia.

Cable Acceptance - Alternatives

Gland Diameter	Gland Part No.	Gland Colour	Additional Suffix
6-8mm	12023	Black	Standard for 2-12 Contact
3.5-5mm	SA3426	Grey	Suffix /04†
5-7mm	12023/1	White	Suffix /05
7-9mm	12023/2	Yellow	Suffix /07*
Gland Pack	SA3253	Pack of 3 glands to suit cables 3.5-5mm, 5-7mm & 7-9mm dia†	

\*Note: 7-9mm gland standard for 25 way, no suffix required.  
†Includes additional black gland cage for 3.5-5mm dia. cable range.

To order connector with alternative cable gland add suffix to part no. e.g. PXV0731/P/07 = PXV0731 3 Plug connector with cable gland to suit 7-9mm dia. cable.

Cable Acceptance - Standard as supplied

No. Contacts	Cable Diameter or Type
2-12 Contact	6-8mm
25 Contact	7-9mm

Sealing Cap and Assembling Tool



PXV0734 & PXV0733

- Average PCF reduction of 1.5 kg CO<sub>2</sub>e per 100 units
- Maintains IP68 Rating of Unmated Connectors
- Can be used to remove Inserts
- PXV0734 for Flex Cable Connector
- PXV0733 for Inline, Front Panel, Bulkhead and Flange mount connectors
- PXV0711 for PCB and Rear Panel Mount connectors

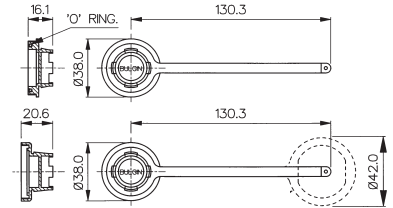

Rear of Panel Back Shell



PXV0799

- PCF reduction of 8.9 kg CO<sub>2</sub>e per 100 units
- Provides environmental seal to rear of panel
- Standard cable acceptance 6-8mm, 3.5 to 9mm with alternative glands
- For use on front panel mounting connectors
- Replaces mounting nut in panel connector

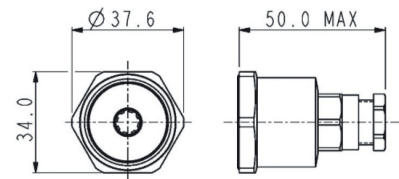

PVC Insulation Boot



12855

- Shock protection for rear of connector
- Flammability Rating UL94V-0
- Fits Front Panel Mount Versions only

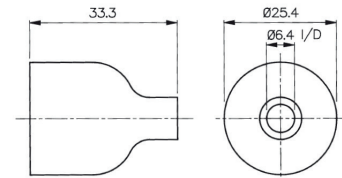

Cable Support Accessory



12237/R

- PCF reduction of 3.3 kg CO<sub>2</sub>e per 100 units
- Gives extra support to the cable
- Suitable for 5-7mm and 7-9mm Cable Diameters

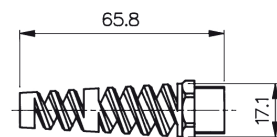

PXV0XXX	X	XX
Body Styles	Contacts Type	Cable Acceptance or PCB/Rear Panel Mounting
PXV0707	P = Plug	Flex Cable and Inline Connectors cable acceptance use:
PXV0708	S = Socket	Blank = 6-8mm (Black) standard for 2-12 Contact
PXV0709		
PXV0727		04 = 3.5-5mm (Grey)
PXV0728		05 = 5-7mm (White)
PXV0729		07 = 7-9mm (Yellow)
PXV0730		(standard for 25 way, no suffix required)
PXV0731		
PXV0732		PCB (PX0707) and Rear Panel Mount connectors
PXV0735		(PX0708 and PX0709) use:
PXV0736		02 = 2 Contact
PXV0737		03 = 3 Contact
PXV0738		04 = 4 Contact
PXV0739		06 = 6 Contact
PXV0740		07 = 7 Contact
PXV0744		09 = 9 Contact
PXV0745		12 = 12 Contact
PXV0746		25 = 25 Contact
PXV0747		Front Panel, Bulkhead and Flange Mount - not required
PXV0748		
PXV0749		
PXV0756		
PXV0757		
PXV0758		
PXV0760		
PXV0761		
PXV0762		
PXV0764		
PXV0765		
PXV0766		
PXV0767		
PXV0768		
PXV0769		
PXV0776		
PXV0778		
PXV0779		
PXV0781		
PXV0787		
PXV0794		
PXV0795		
PXV0796		
PXV0797		
PXV0798		

**Examples:**

PXV0707/P/06= PCB Panel connector, Plug contacts, 6 Contact  
 PXV0731/S = Flex Cable connector, socket contacts, 3 Contact  
 PXV0732/P/07 = Inline Cable connector, Plug contacts, 3 Contact, 7-9mm cable acceptance

PXV0XXX	X	XX
Body Styles .. continued	Contacts Type	Cable Acceptance or PCB/Rear Panel Mounting
PXV0820		
PXV0821		
PXV0822		
PXV0823		
PXV0824		

PCB Layouts

Sockets

Contact Nos viewed from rear of panel

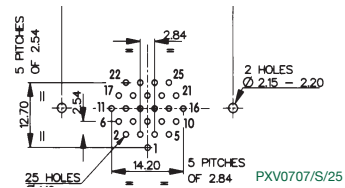
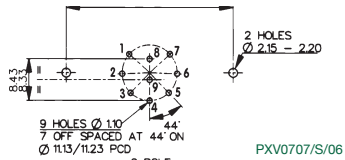
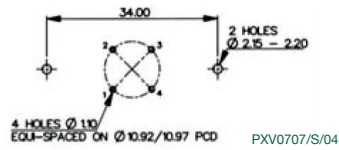
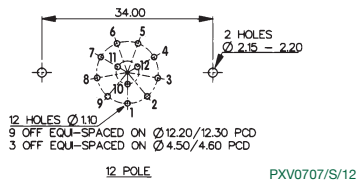
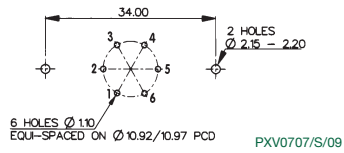
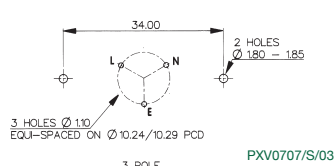

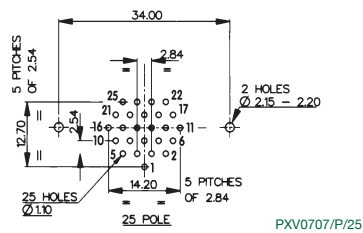
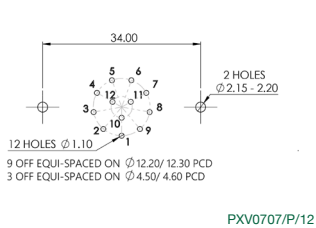
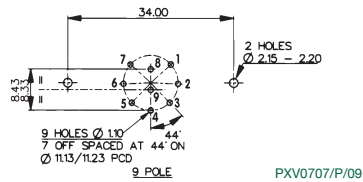
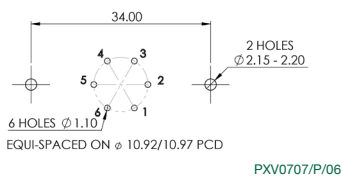
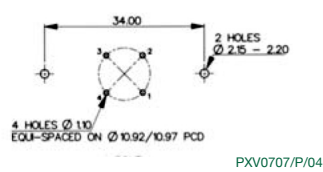
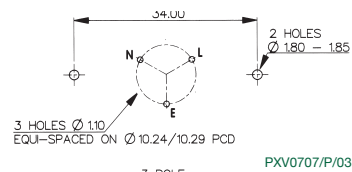

Plugs

Contact Nos viewed from rear of panel



### Electrical:

No. Contacts:	2, 3	4	6, 7	9	12	25
Current Rating:						
VDE	12A	10A	5A	5A	5A	1A
UL	12A	10A	5A	5A	5A	1A
Voltage Rating (AC/DC):	277V	277V	277V	150V	50V	50V
Contact Resistance:	<10mΩ (2-9 Contact)					
	<5mΩ (12 Contact)					
	<5mΩ (25 Contact)					
Insulation Resistance:	>10 <sup>4</sup> MΩ @ 500V DC (2-9 Contact)					
AC Breakdown voltage:	4kV Contact - Contact (2-9 Contact)					
	6kV Contacts - Panel (Low Profile Flange and Panel Types – 2-9 Contact)					
	7.5kV Contacts - Panel (Other Types – 2-9 Contact)					
Operating Temp. Range:	-20°C to +70°C					
Approvals:						
 UL (Underwriters Laboratories)	E93288 and E337507					
 VDE (Verband der Elektrotechnik)	40023148					

### Material:

Body Mouldings:	Glass Filled Polyamide UL94HB
Inserts (2-25 Contact):	Polyamide UL94V-0
PXV0707	Polyamide UL94V-0
PXV0708	Polyamide UL94V-0
PXV0709	Polyamide UL94V-0
Contacts:	
Screw Terminal:	Brass, Nickel Plated
Crimp (9 Contact):	Copper Alloy, Tin Plated
Crimp/Solder (12+25 Contact):	Copper Alloy, Gold Plated (0.1µm on Nickel)

 Compliant

### Mechanical:

Sealing:	IP69K, Tested in accordance with BS ISO 20653:2023
	IP68, EN 60529:1992+A2:2013 Tested @ 1.054kg/sq.cm. (15lb/sq.in.) 10m depth for 2 weeks.
	EN 60529:1992 +A2:2013 Tested @ 9.84kg/sq.cm. (140lb/sq.in.) 100m depth for 12 hours.
Salt Mist:	EN 60068-2-52 Test Kb Salt Mist (Cyclic) Marine Severity Level 1
Cable Acceptance:	
2-12 Contact - standard gland:	6-8mm dia
2-12 Contact - alternative glands:	3.5-9mm dia
25 Contact - standard gland:	7-9mm dia
25 Contact - alternative glands:	3.5-7mm dia
Contact Accommodation:	
2 and 3 Contact screw terminals:	2.5-4mm <sup>2</sup> (12-14AWG)
3 Contact crimp:	1-1.5mm <sup>2</sup> (16-17AWG)
4, 6 and 7 Contact:	1-1.5mm <sup>2</sup> (16-17AWG)
9 Contact:	0.14-0.25mm <sup>2</sup> (24-26AWG)
12 Contact:	0.25-0.34mm <sup>2</sup> (22-24AWG)
25 Contact:	0.14-0.25mm <sup>2</sup> (24-26AWG)
Terminations:	
2-7 Contact:	Screw Terminals
3 Contact:	Screw Terminals & Crimp Contacts
9 Contact:	Crimp Contacts
12 Contact:	Crimp & Solder Contacts
25 Contact:	Crimp & Solder Contacts
Tightening Torques:	
Flex Mounting/Inline:	Gland Nut: 1.13Nm (10lbf.in.)
Panel Mounting:	Rear Fixing Nut: 1.7Nm (15lbf.in.) Front Fixing Nut: 1.4Nm (12.4lbf.in.)
Bulkhead and Low Profile Flange Mounting:	4 x M3 Countersunk Head Fixing Screws (using washers supplied) 0.34Nm (3lbf.in.)
Sealings Caps/Locking Ring:	1.13Nm (10lbf.in.)
Rear thread, Front Panel Connector:	M27 x 1.0-6H
Thread, Rear Panel Connector:	M35 x 1.0-6H

Cable Joiner



PXV0777

- Average PCF reduction of 7.8 kg CO<sub>2</sub>e per 100 units
- IP68 & IP69K Rating for Sealed Inline Connections
- Standard Cable Acceptance 6-8mm
- Cable Range 3.5-9mm (using alternative glands)
- Supplied with 3, 4, 6 or 8-way terminal block

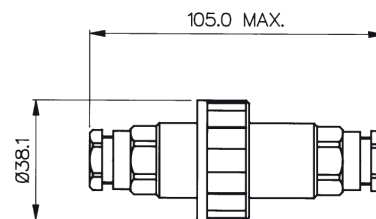

**Specifications**

**PXV0777**

**PXV0777/4POLE, 6POLE, 8POLE**

**POLE Configurations**

Rating:	16A, 250V AC	10A, 250V AC	
Wire Termination:	3 way Terminal Block	4, 6, 8 way Terminal Block	
Conductor Accommodation:	2.5mm <sup>2</sup> max (14AWG)	1.5mm <sup>2</sup> max (16AWG)	
Cable Acceptance:	6-8mm dia alternative glands available on request	6-8mm dia alternative glands available on request	
Material:	Glass Filled Polyamide UL94-V0	Glass Filled Polyamide UL94-V0	
Sealing:	IP68 to BS EN 60529 : 1992 1.054kg/sq.cm. (15lbs/sq.in.) 10m depth for 2 weeks	IP68 to BS EN 60529 : 1992 1.054kg/sq.cm. (15lbs/sq.in.) 10m depth for 2 weeks	
Salt Mist	IP69K to DIN 40050-9	IP69K to BS ISO 20653:2023	
Operating Temp. Range:	EN 60068-2-52 Test Kb Salt Mist (Cyclic) Marine Severity Level 1	EN 60068-2-52 Test Kb Salt Mist (Cyclic) Marine Severity Level 1	
Operating Temp. Range:	-20°C to +70°C	-20°C to +70°C	
Colour:	Black	Black	
RoHS	Compliant	Compliant	

**Examples**

**PXV0777** – 3 Contact 6-8mm Black.

**PXV0777/04** – 3 Contact 3.5-5.0mm Black.

**PXV0777/4POLE** – 4 Contact 6-8mm Black.

**PXV0777/6POLE/04** – 6 Contact 3.5-5.0mm Black.

PXV0777	XPOLE	XX
Part No	Blank = 3 Contact	Blank = 6-8mm
	4POLE = 4 Contact	04 = 3.5-5mm
	6POLE = 6 Contact	05 = 5-7mm
	8POLE = 8 Contact	07 = 7-9mm

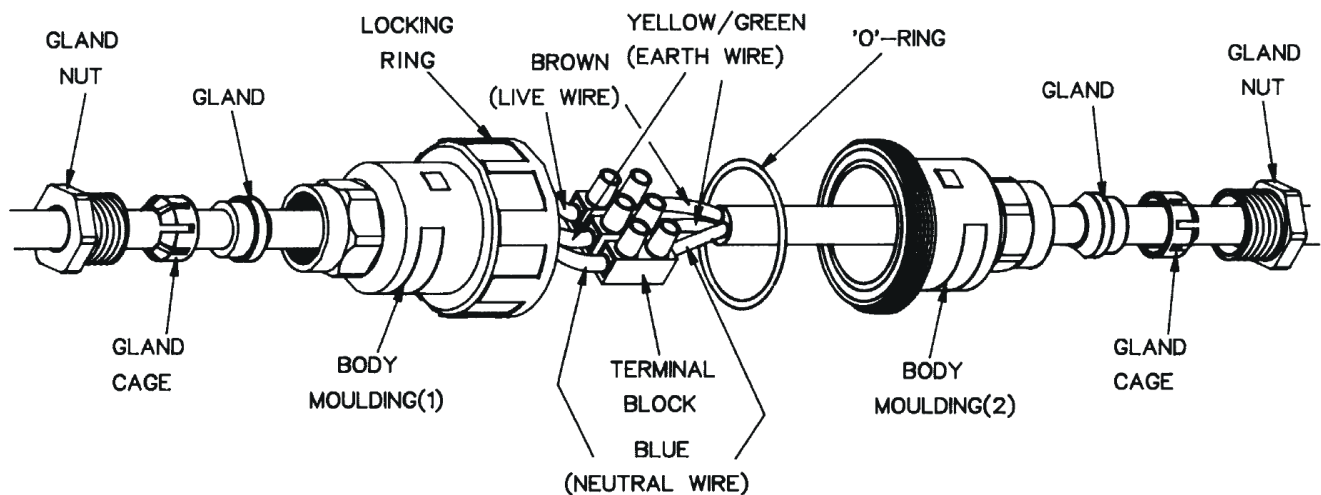

1. Strip wires to dimensions shown.
2. Assemble components parts onto cable as shown, then connect wires to terminal block.

ENSURE WIRES CONNECTED INTO ONE SIDE OF TERMINAL BLOCK MATCH WIRES CONNECTED INTO THE OTHER SIDE.

i.e. Brown to Brown (Live)  
 Blue to Blue (Neutral)  
 Green/Yellow to Green/Yellow (Earth)

3. Bring the two body mouldings together ensuring the 'O' ring is correctly located in groove then lock together with locking ring, ensure ring is fully tightened.

Put gland cage over gland and push fully home into its appropriate body then fully tighten gland nuts.

4. To ensure a good seal, all surfaces must be completely free of dust, grease or any other contamination.

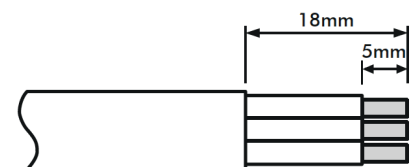

Wire stripping details

THIS CABLE CONNECTOR IS SUITABLE FOR USE WITH LOADS NOT EXCEEDING 16 AMPS USING 1.5mm<sup>2</sup> CABLE

ALWAYS USE WITH SUPPLY PROTECTED BY AN RCD (RESIDUAL CURRENT DEVICE), IF IN DOUBT CONSULT A QUALIFIED ELECTRICIAN.

**DANGER**

DISCONNECT MAINS  
 SUPPLY BEFORE  
 DISMANTLING  
 CONNECTOR